

A N T H E M

OPERATING INSTRUCTIONS

BLX 200

BLU-RAY DISC PLAYER



IMPORTANT SAFETY INSTRUCTIONS



1. Read these instructions.
2. Keep these instructions.
3. Heed all warnings.
4. Follow all instructions.
5. Do not use this apparatus near water.
6. Clean only with dry cloth.
7. Do not block any ventilation openings.
Install in accordance with the manufacturer's instructions.
8. Do not install near any heat sources such as radiators, heat registers, stoves, or other apparatus (including amplifiers) that produce heat.
9. Do not defeat the safety purpose of the polarized or grounding-type plug. A polarized plug has two blades with one wider than the other.
A grounding type plug has two blades and a third grounding prong. The wide blade or the third prong are provided for your safety. If the provided plug does not fit into your outlet, consult an electrician for replacement of the obsolete outlet.
10. Protect the power cord from being walked on or pinched particularly at plugs, convenience receptacles, and the point where they exit from the apparatus.
11. Only use attachments/accessories specified by the manufacturer.
12. Use only with the cart, stand, tripod, bracket, or table specified by the manufacturer, or sold with the apparatus.
When a cart is used, use caution when moving the cart/apparatus combination to avoid injury from tip-over.
13. Unplug this apparatus during lightning storms or when unused for long periods of time.
14. Refer all servicing to qualified service personnel.
Servicing is required when the apparatus has been damaged in any way, such as power-supply cord or plug is damaged, liquid has been spilled or objects have fallen into the apparatus, the apparatus has been exposed to rain or moisture, does not operate normally, or has been dropped.



PORTABLE CART WARNING

Introduction

READ THIS BEFORE OPERATING YOUR UNIT

	 <p>This symbol is intended to alert the user to the presence of uninsulated "dangerous voltage" within the product's enclosure that may be of sufficient magnitude to constitute a risk of electric shock to persons.</p>
<p>CAUTION : TO REDUCE THE RISK OF ELECTRIC SHOCK, DO NOT REMOVE COVER (OR BACK). NO USER-SERVICEABLE PARTS INSIDE. REFER SERVICING TO QUALIFIED SERVICE PERSONNEL.</p>	 <p>This symbol is intended to alert the user to the presence of important operating and maintenance (servicing) instructions in the literature accompanying the appliance.</p>

WARNING : TO REDUCE THE RISK OF FIRE OR ELECTRIC SHOCK, DO NOT EXPOSE THIS APPLIANCE TO RAIN OR MOISTURE.

FCC INFORMATION (FOR U.S.A.)

This equipment has been tested and found to comply with the limits for a Class B digital device, pursuant to Part 15 of the FCC Rules. These limits are designed to provide reasonable protection against harmful interference in a residential installation. This equipment generates, uses and can radiate radio frequency energy and, if not installed and used in accordance with the instructions, may cause harmful interference to radio communications. However, there is no guarantee that interference will not occur in a particular installation. If this equipment does cause harmful interference to radio or television reception, which can be determined by turning the equipment off and on, the user is encouraged to try to correct the interference by one or more of the following measures:

- Reorient or relocate the receiving antenna.
- Increase the separation between the equipment and receiver.
- Connect the equipment into an outlet on a circuit different from that to which the receiver is connected.
- Consult the dealer or an experienced radio/TV technician for help.

Caution : Any changes or modifications in construction of this device which are not expressly approved by the party responsible for compliance could void the user's authority to operate the equipment.

This Class B digital apparatus complies with Canadian ICES-003.

Cet appareil numérique de la Classe B est conforme à la norme NMB-003 du Canada.

**CLASS 1
LASER PRODUCT**

CAUTION

Invisible laser radiation when the unit is open.
Do not stare into beam.

CAUTION : USE OF ANY CONTROLS, ADJUSTMENTS, OR PROCEDURES OTHER THAN THOSE SPECIFIED HEREIN MAY RESULT IN HAZARDOUS RADIATION EXPOSURE.

FOR YOUR SAFETY

<p>U.S.A CANADA</p>	<p>120 V</p>	<p>Units shipped to the U.S.A and CANADA are designed for operation on 120 V AC only. Safety precaution with use of a polarized AC plug. However, some products may be supplied with a nonpolarized plug.</p> <p>CAUTION : To prevent electric shock, match wide blade of plug to wide slot, fully insert.</p> <p>ATTENTION : Pour éviter chocs électriques, introduire la lame la plus large de la fiche dans la borne correspondante de la prise et pousser jusqu' au fond.</p>
<p>EUROPE</p>	<p>220 V - 240 V</p>	<p>To ensure safe operation, the three-pin plug supplied must be inserted only into a standard three-pin power point which is effectively earthed through the normal household wiring. Extension cords used with the equipment must be three-core and be correctly wired to provide connection to earth. Improper extension cords are a major cause of fatalities. The fact that the equipment operates satisfactorily does not imply that the power point is earthed and that the installation is completely safe. For your safety, if in any doubt about the effective earthing of the power point, consult a qualified electrician.</p> <p>PAN-EUROPEAN UNIFIED VOLTAGE All units are suitable for use on supplies 220-240 V AC.</p>

ENGLISH



ENERGY STAR® is a U.S. registered mark. As an ENERGY STAR® Partner, Sherwood has determined that this product meets the ENERGY STAR® guidelines for energy efficiency.



Information for Users on Collection and Disposal of Old Equipment and used Batteries

These symbols on the products, packaging, and/or accompanying documents mean that used electrical and electronic products and batteries should not be mixed with general household waste. For proper treatment, recovery and recycling of old products and used batteries, please take them to applicable collection points, in accordance with your national legislation.



By disposing of these products and batteries correctly, you will help to save valuable resources and prevent any potential negative effects on human health and the environment which could otherwise arise from inappropriate waste handling.



For more information about collection and recycling of old products and batteries, please contact your local municipality, your waste disposal service or the point of sale where you purchased the items.

Pb

[Information on Disposal in other Countries outside the European Union]

These symbols are only valid in the European Union. If you wish to discard these items, please contact your local authorities or dealer and ask for the correct method of disposal.

Note for the battery symbol (bottom two symbol examples):
The sign Pb below the symbol for batteries indicates that this batteries contains lead.

CAUTION

- Leave a space around the unit for sufficient ventilation.
- Avoid installation in extremely hot or cold locations, or in an area that is exposed to direct sunlight or heating equipment.
- Keep the unit free from moisture, water, and dust.
- Do not let foreign objects in the unit.
- The ventilation should not be impeded by covering the ventilation openings with items, such as newspapers, table-cloths, curtains, etc.
- No naked flame sources, such as lighted candles, should be placed on the unit.
- Please be care the environmental aspects of battery disposal.
- The unit shall not be exposed to dripping or splashing for use.
- No objects filled with liquids, such as vases, shall be placed on the unit.
- Do not let insecticides, benzene, and thinner come in contact with the set.
- Never disassemble or modify the unit in any way.
- **Notes on the AC power cord and the wall outlet.**
- The unit is not disconnected from the AC power source(mains) as long as it is connected to the wall outlet, even if the unit has been turned off.
- To completely disconnect this product from the mains, disconnect the plug from the wall socket outlet.
- When setting up this product, make sure that the AC outlet you are using is easily accessible.
- Disconnect the plug from the wall outlet when not using the unit for long periods of time.

PRECAUTIONS

■ Moisture condensation

Moisture may form on the lens in the following conditions.

- Immediately after a heater has been turned on.
- In a steamy or very humid room.
- When this unit is moved from a cold place to a warm one.

If moisture forms inside this unit, it may not operate properly.

In this case, turn on the power and wait about one hour for the moisture to evaporate.

■ If there is noise interference on the TV while a broadcast is being received.

Depending on the reception condition of the TV, interference may appear on the TV screen while you are watching a TV broadcast and this unit is left on. This is not a malfunction of this unit or the TV. To watch a TV broadcast, turn off this unit.

■ Do not transport this unit with discs left in it.

■ Do not place on the component such as amplifier or receiver that generates heat.

If so, the temperature inside this unit rises and malfunction may occur.

CONTENTS

• IMPORTANT SAFETY INSTRUCTIONS	2
• Introduction	
READ THIS BEFORE OPERATING YOUR UNIT	3
• System Connections	
CONNECTING TO A/V AMPLIFIER OR RECEIVER	6
CONNECTION TO TV WITH HDMI IN CONNECTOR	8
CONNECTING TO NETWORK	9
CONNECTING MULTI-ROOM SYSTEM KIT	9
• Front Panel Controls	12
• Remote Controls	13
REMOTE CONTROL OPERATION RANGE	14
LOADING BATTERIES	14
• Preliminary Knowledge About Discs	
PLAYABLE DISC TYPES	15
REGION CODE	15
NOTES ON COPYRIGHT	16
SYMBOL ABOUT INVALID OPERATION	16
PLAYABLE FILES	16
CARE AND HANDLING OF DISCS	16
• Operations	
PLAYING A DISC	17
ENJOYING BONUSVIEW OR BD-LIVE	23
PLAYING FILES	24
• System Settings	29
SETTING THE SYSTEM	30
SETTING THE DISPLAY	31
SETTING THE AUDIO	32
SETTING THE LANGUAGE	33
SETTING THE PARENTAL CONTROL	34
SETTING THE NETWORK	35
• Definition Of Terms	37
• Troubleshooting Guide	39
• Specifications	40
• License	41
• Limited Warranty	45

ENGLISH

System Connections

- Do not connect the AC input cord into the AC outlet when plugging and unplugging connection cords.
- Since different components often have different terminal names, carefully read the operating instructions of the component connected.
- Be sure to observe the color coding when connecting audio and video cords.
- The supplied cords are a (stereo) audio cord and a composite video cord. Other cords are commercially-available cords.

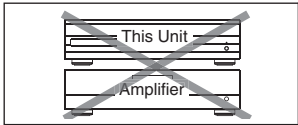

Caution : Do not stack this unit on the amplifier, etc. such as heating equipment. This could damage this unit and/or the amplifier or could result in malfunction.

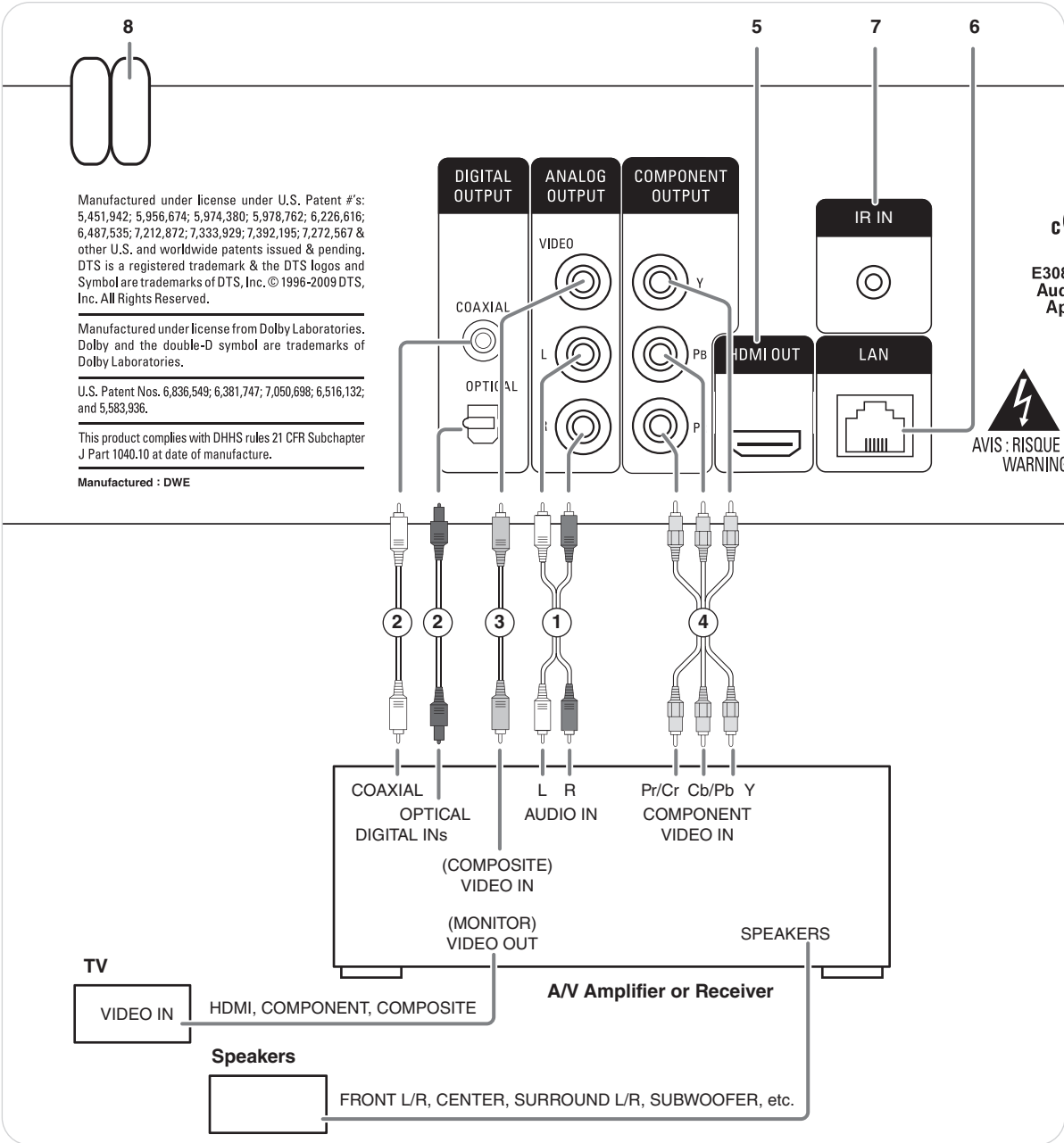

CONNECTING TO A/V AMPLIFIER OR RECEIVER



■About video/HDMI OUT jacks



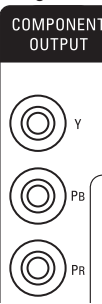

- You don't need to make all kinds of video connections between components. (e/ g., this unit to A/V amplifier, A/V amplifier to TV and so on.)

Depending on what kinds of video jacks that A/V amplifier TV, etc. has, we recommend you to make the same kinds of video connections between components.

Jack type	Video resolution
High quality Digital 	High Definition : 1080/24p, 1080p, 1080i, 720p Standard Definition : 480p(/576p), 480i(/576i)
Analog 	High Definition : 1080i, 720p Standard Definition : 480p(/576p), 480i(/576i)
Standard quality VIDEO 	Standard Definition : 480i(/576i)

■About audio/HDMI OUT jacks

- You don't need to make all kinds of audio connections, too.
Connect this unit to A/V amplifier depending on the audio input jack that A/V amplifier has.

Jack type	Audio quality
High quality Digital 	Standard quality Analog 
COAXIAL  OPTICAL 	

1. Connecting AUDIO OUTs

- Connect these jacks to the AUDIO IN jacks of BD(DVD, CD, etc.) of your amplifier.

2. Connecting DIGITAL AUDIO OUTs

- Connect either the OPTICAL or the COAXIAL DIGITAL OUT jack to the corresponding DIGITAL IN jack of your amplifier. (You don't need to do both.)

■Notes :

- When your amplifier is not compatible with the digital signals that are output from this unit, loud noise or no sound may be heard from the speakers, and it may be harmful to your ears and damages the speakers. To prevent it, you should disconnect the DIGITAL OUTs to your amplifier and make analog audio connection.
- When making the COAXIAL DIGITAL connection, be sure to use a 75Ω COAXIAL cord, not a conventional AUDIO cord.

3. Connecting COMPOSITE VIDEO OUT

- Connect this jack to the (composite)VIDEO IN jack of your amplifier or TV.

4. Connecting COMPONENT VIDEO OUTs

- Connect these jacks to the COMPONENT VIDEO OUT jacks of your amplifier or TV.
- When making COMPONENT VIDEO connections, connect "Y" to "Y", "PB" to "PB" (, "Cb", "B-Y"), "PR" to "PR" (, "Cr", "R-Y").

■Notes :

- If the resolutions of the video signals which are output from the COMPONENT VIDEO OUTs and/or the HDMI OUT and your TV are not matched, the picture is not clear, natural or displayed.
To prevent it, you should set the Resolution to one which the TV can handle. (For details, refer to "SETTING THE DISPLAY" on page 31.)
- Do not connect the unit to the TV through a VCR. Otherwise the picture may be disturbed due to the copy protection function.

5. HDMI OUT CONNECTOR

- Refer to "CONNECTING TO TV WITH HDMI IN CONNECTOR" on next page.

6. LAN CONNECTOR

- Refer to "CONNECTING TO NETWORK" on page 9.

7. IR IN JACK

- Refer to "CONNECTING MULTI-ROOM SYSTEM KIT" on page 9.

8. AC INPUT CORD

- Plug the cord into a wall AC outlet.

CONNECTING TO TV WITH HDMI IN CONNECTOR

- If you have a HDMI IN connector equipped TV or projector, etc., connected it to the HDMI OUT connector of this unit using a commercially available HDMI cord.
The HDMI connection can carry uncompressed digital video and multi-channel (up to 7.1ch) digital audio signals.
- Among the HDMI IN connector equipped TV or projector, etc., some do not support audio output (for examples, projectors). In such a case, make an audio connection between this unit and A/V amplifier.
- If you have a DVI IN connector equipped TV or projector, etc., compatible with both DVI and High-bandwidth Digital Content Protection (HDCP), connect it to the HDMI OUT connector of this unit using a commercially available HDMI-DVI converter cord.
Since the HDMI-to-DVI connection cannot carry audio signals, you should make an audio connection. (For details on audio connection, refer to the operating instructions of the DVI IN connector equipped component.)
- If you have a HDMI or DVI connector equipped A/V amplifier, you can connect this unit to TV or projector, etc., through A/V amplifier. (For details on connection between components, refer to the operating instructions of your amplifier.)

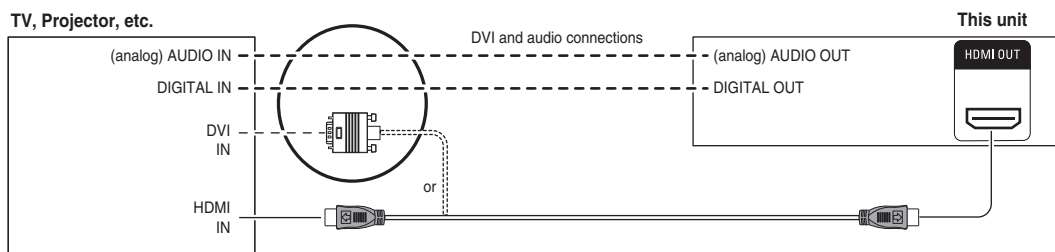

■ Copyright protection system

- This unit supports HDCP (High-bandwidth Digital Contents Protection), technology to protect copyright of digital video signals against illegal duplication. HDCP must also be supported on the components connected to this unit.
If a component incompatible with HDCP is connected, the video signals will not be output properly.
- This unit is HDMI Ver. 1.3 compatible.
- HDMI, the HDMI logo and High-Definition Multimedia Interface are trademarks or registered trademarks of HDMI licensing LLC.

■ Notes :

- When connecting the HDMI OUT connector to TV or projector, etc., you should set Display and Audio settings correctly. (For details, refer to "SETTING THE DISPLAY" on page 31 and "SETTING THE AUDIO" on page 32.)
- For stable signal transfer, we recommend using HDMI cords that are a maximum of 5 meters in length.
- Among the components that support HDMI, some components can control other components via the HDMI connector. However, this unit cannot be controlled by another component via the HDMI connector.
- The audio signals from the HDMI connector (including the sampling frequency and bit length) may be limited by the component that is connected.

CONNECTING TO NETWORK

- You can enjoy a variety of contents with interactive functions by connecting to the internet when playing BD-LIVE compatible discs.
- Connect the LAN connector of this unit to your internet source.

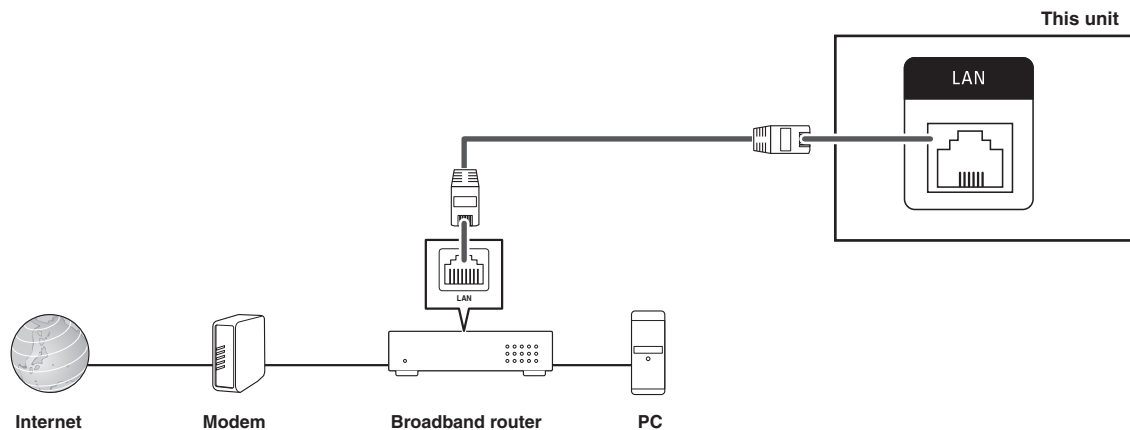

■ Notes :

- After making a broadband internet connection, you should set the communication setting. (For details, refer to “SETTING THE NETWORK” on page 35.)
- When using a broadband internet connection, a contract with an internet service provider is required. For more information, contact your nearest internet service provider.
- Refer to the operating instructions of the equipment because the connected equipment and connection method may differ depending on your internet environment.
- Use a LAN cable/router supporting 10 BASE-T/100 BASE-TX.
- Some LAN cables are easily affected by noise. We recommend using a shielded type cable.

CONNECTING MULTI-ROOM SYSTEM KIT

- The multi-room system kit(sold separately) is essential for operation from a remote location .
For information on the multi-room system kit, contact the Xantech corporation at 1-800-843-5465 or www.xantech.com.
- IR IN jack allows you to control this unit from other room with the remote control unit.
- To control this unit from other room with the remote control unit, connect the IR IN jack to the output of the connecting block.

■ Note :

- Remote operation may become unreliable if the IR receiver is exposed to strong light such as direct sunlight or inverted fluorescent.

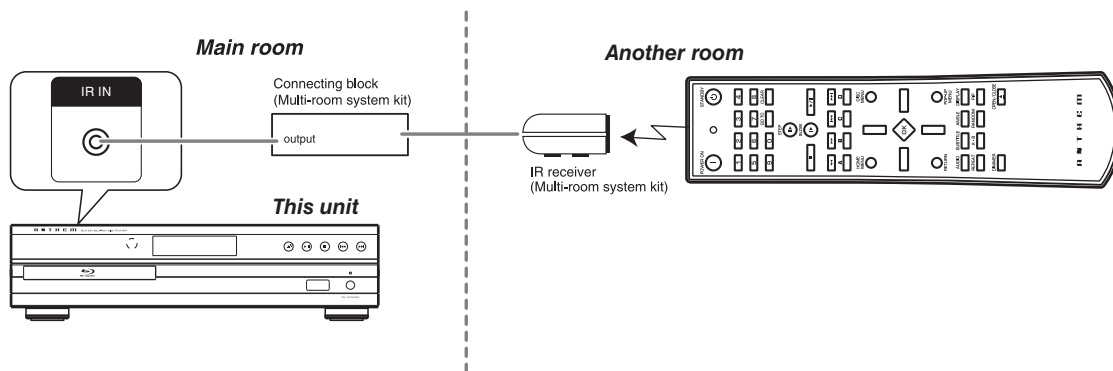

■ Video output resolution

- The video output resolution differs depending on the Resolution setting.
(For details, refer to “SETTING THE DISPLAY” on page 31.)

Resolution setting	Video OUTs		
	(Composite) VIDEO OUT	COMPONENT OUTs	HDMI OUT
HDMI Auto	480i(NTSC)(or 576i(PAL))	1080i*1,*2	highest resolution
1080p	480i(NTSC)(or 576i(PAL))	1080i*1,*2	1080p
1080i	480i(NTSC)(or 576i(PAL))	1080i*1,*2	1080i
720p	480i(NTSC)(or 576i(PAL))	720p*1,*2	720p
480p	480i(NTSC)(or 576i(PAL))	480p(NTSC)(or 576p(PAL))	480p(NTSC)(or 576p(PAL))
480i	480i(NTSC)(or 576i(PAL))	480i(NTSC)(or 576i(PAL))	480i(NTSC)(or 576i(PAL))

*1 : • When the COMPONENT OUTs and the HDMI OUT are connected to your TV, the video signals of 480i(NTSC)(or 576i(PAL)) will be output.

*2 : • When the HDMI OUT is not connected to your TV and the copy protected DVD Videos are played, the video signals of 480p(or 576p) will be output.

■ Notes :

- If the resolution of video signal to be output from COMPONENT OUTs or HDMI OUT does not match that of your TV, the picture is not clear, natural or displayed.
Should this happen, first make (composite) video connection between this unit and TV, and select the (composite) VIDEO as an input source on the TV to display the setting menu, then set the Resolution correctly. (For details on the resolution acceptable for your TV, refer to its operating instructions.)
- When the HDMI OUT connector is connected to your TV, the TV reports to this unit what resolutions it supports. Therefore, if you set the Resolution to HDMI Auto, this unit outputs the video signals of the highest resolution acceptable for your TV. In this case, you cannot select the resolution unacceptable for your TV.

■ Audio output signals

- The audio output differs as follows, depending on the audio format, output jack and Digital Output settings.
(For details, refer to “SETTING THE AUDIO” on page 32.)
- When the Digital Output is set to Off, no digital audio signals will be output from the HDMI OUT or the OPTICAL/COAXIAL DIGITAL OUTs.

Audio format	Digital Output setting	Digital		Analog
		HDMI OUT *1	OPTICAL/COAXIAL OUTs	AUDIO OUTs
Dolby Digital	Bitstream HD	Dolby Digital 5.1CH	Dolby Digital 5.1CH	2CH
	Bitstream Legacy	Dolby Digital 5.1CH	Dolby Digital 5.1CH	
	Bitstream Mixed	DTS 5.1CH	DTS 5.1CH	
	PCM 7.1	PCM 5.1CH	PCM 2CH	
	PCM 5.1	PCM 5.1CH	PCM 2CH	
	PCM Stereo	PCM 2CH	PCM 2CH	
Dolby Digital Plus/ Dolby TrueHD	Bitstream HD	Dolby Digital Plus 7.1CH*2 / Dolby TrueHD 7.1CH*2	PCM 2CH*3	2CH
	Bitstream Legacy	Dolby Digital 5.1CH	Dolby Digital 5.1CH	
	Bitstream Mixed	DTS 5.1CH	DTS 5.1CH	
	PCM 7.1	PCM 7.1CH	PCM 2CH*3	
	PCM 5.1	PCM 5.1CH	PCM 2CH*3	
	PCM Stereo	PCM 2CH	PCM 2CH*3	
DTS-HD High Resolution Audio/DTS-HD Master Audio	Bitstream HD	DTS-HD High Resolution Audio 7.1CH*2/DTS-HD Master Audio 7.1CH*2	PCM 2CH	2CH
	Bitstream Legacy	DTS 5.1CH	DTS 5.1CH	
	Bitstream Mixed	DTS 5.1CH	DTS 5.1CH	
	PCM 7.1	PCM 7.1CH	PCM 2CH	
	PCM 5.1	PCM 5.1CH	PCM 2CH	
	PCM Stereo	PCM 2CH	PCM 2CH	
DTS	Bitstream HD	DTS 5.1CH	DTS 5.1CH	2CH
	Bitstream Legacy	DTS 5.1CH	DTS 5.1CH	
	Bitstream Mixed	DTS 5.1CH	DTS 5.1CH	
	PCM 7.1	PCM 5.1CH	PCM 2CH	
	PCM 5.1	PCM 5.1CH	PCM 2CH	
	PCM Stereo	PCM 2CH	PCM 2CH	
LPCM 7.1CH (48/96 kHz)	Bitstream HD	PCM 7.1CH	PCM 2CH*3	2CH
	Bitstream Legacy	PCM 7.1CH	PCM 2CH*3	
	Bitstream Mixed	DTS 5.1CH	DTS 5.1CH	
	PCM 7.1	PCM 7.1CH	PCM 2CH*3	
	PCM 5.1	PCM 5.1CH	PCM 2CH*3	
	PCM Stereo	PCM 2CH	PCM 2CH*3	
LPCM 5.1CH (192 kHz)	Bitstream HD	PCM 2CH	PCM 2CH*3	2CH
	Bitstream Legacy	PCM 2CH	PCM 2CH*3	
	Bitstream Mixed	DTS 2CH	PCM 2CH*3	
	PCM 7.1	PCM 2CH	PCM 2CH*3	
	PCM 5.1	PCM 2CH	PCM 2CH*3	
	PCM Stereo	PCM 2CH	PCM 2CH*3	
LPCM 2CH (48/44.1 kHz)	Bitstream HD	PCM 2CH	PCM 2CH	2CH
	Bitstream Legacy	PCM 2CH	PCM 2CH	
	Bitstream Mixed	DTS 2CH	DTS 2CH	
	PCM 7.1	PCM 2CH	PCM 2CH	
	PCM 5.1	PCM 2CH	PCM 2CH	
	PCM Stereo	PCM 2CH	PCM 2CH	

*1 : • When the A/V amplifier does not support HD Audio (Dolby Digital Plus, Dolby TrueHD, DTS-HD High Resolution Audio and DTS-HD Master Audio) but supports Dolby Digital/DTS, a Dolby Digital or DTS bitstream is output.

• When the A/V amplifier does not support HD Audio and Dolby Digital/DTS but supports multi-channel LPCM, up to PCM 7.1CH is output.

• When the A/V amplifier does not support LPCM at higher sampling frequency, LPCM at lower sampling frequency is output.

*2 : When the A/V amplifier supports HD Audio, HD Audio is output.

*3 : When the PCM Downsampling is set to 48 kHz, the audio signal is downsampled to 48 kHz.

ENGLISH

Front Panel Controls

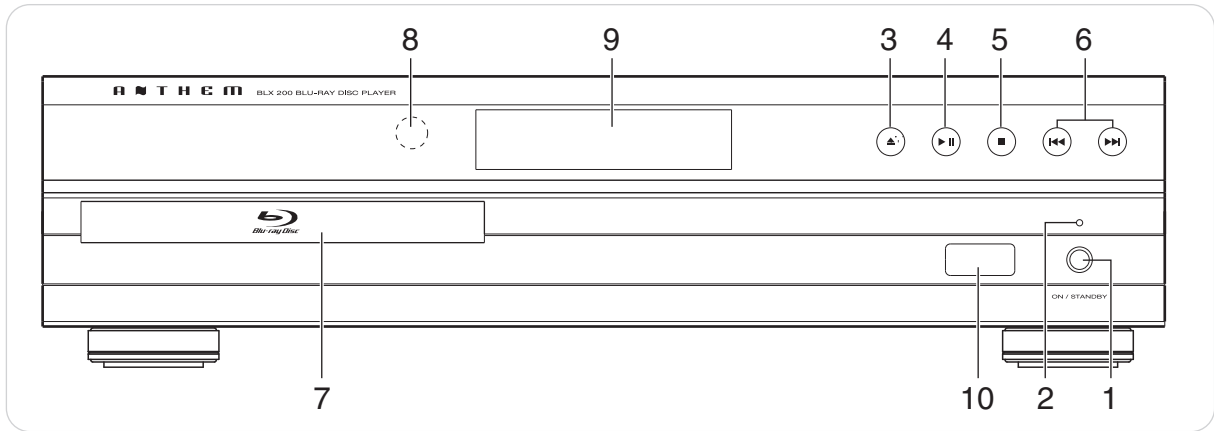

- | | |
|---|---|
| 1. POWER ON/STANDBY button | 7. DISC TRAY |
| 2. POWER ON/STANDBY indicator | 8. REMOTE SENSOR |
| 3. OPEN/CLOSE(▲) button | 9. FLUORESCENT DISPLAY
For details, see below. |
| 4. PLAY/PAUSE(▶) button | 10. USB connector
For details, see below. |
| 5. STOP(■) button | |
| 6. FORWARD/BACKWARD SKIP(▶▶/◀◀) buttons | |

■ FLUORESCENT DISPLAY

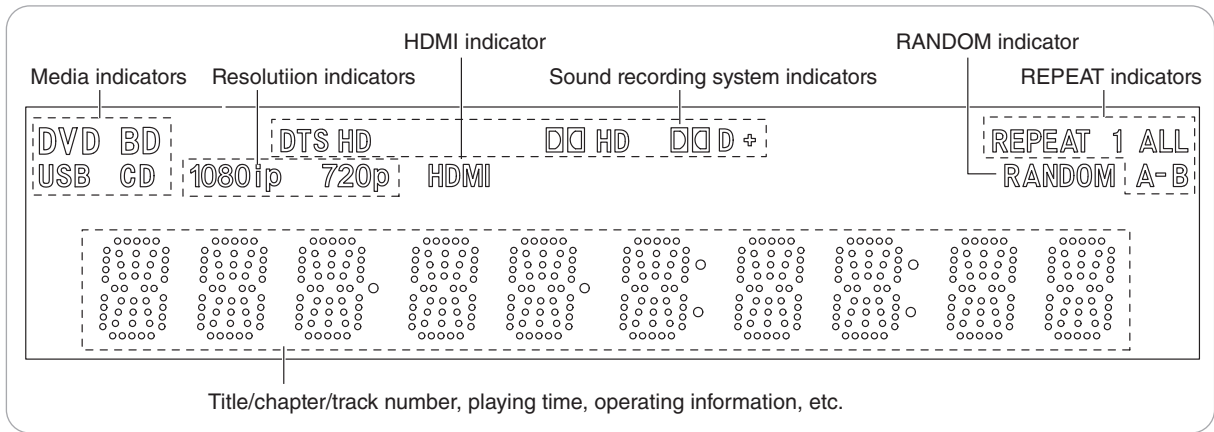

■ USB CONNECTOR

- This connector can be connected to a USB memory device for playback of MP3, WMA or JPEG files stored on it. (For details, refer to “PLAYING FILES” on page 24.)
- To enjoy BONUSVIEW and BD-LIVE functions, you can connect a USB memory device (minimum 1GB capacity (2GB or more recommended)) supporting FAT 32 and USB 2.0 High Speed (480 Mbit/s) to this connector, too. (For details, refer to “ENJOYING BONUSVIEW OR BD-LIVE” on page 23.)

■ Notes :

- The 2GB USB memory device is supplied with.
- Before connecting a USB memory device, open the cover.
- Do not use a USB extension cable when connecting a USB memory device to this connector.
- After playback of files or Virtual Package/BD-LIVE data, remove the USB memory device in the stop mode or the standby mode.

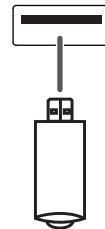

Remote Controls

ENGLISH

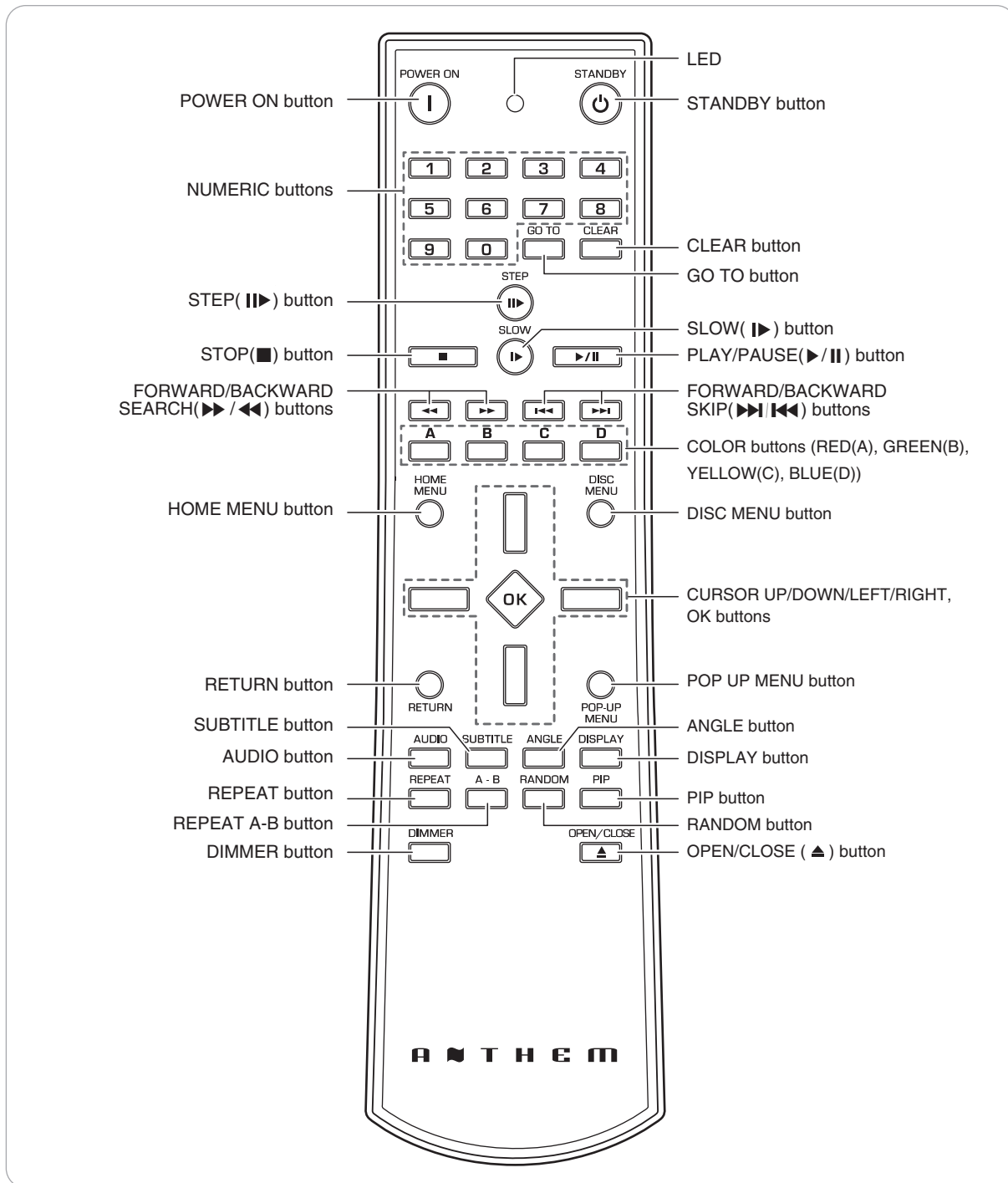

Note :

- You can use the COLOR buttons to select the items on some BD menus.

ENGLISH

REMOTE CONTROL OPERATION RANGE

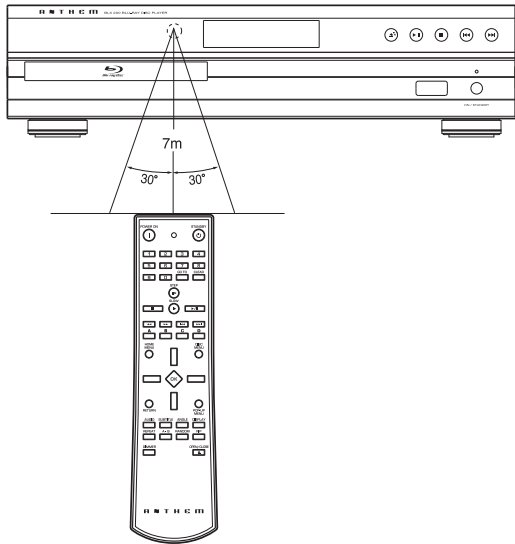

- Use the remote control within a range of about 7 meters (23 feet) and angles of up to 30 degrees aiming at the remote sensor.

LOADING BATTERIES

1. Remove the cover.

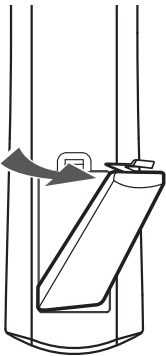

2. Load two batteries ("AAA" size, 1.5V) matching the polarity.









- Remove the batteries when they are not used for a long time.
- Do not use the rechargeable batteries (Ni-Cd type).

Preliminary Knowledge About Discs

PLAYABLE DISC TYPES

This unit supports the following discs.

Type	Logo	Playable format/mode
BD-ROM BD-RE/BD-R		BDMV, AVCHD
DVD Video		DVD-Video
DVD-R		DVD-Video, AVCHD
DVD-RW		DVD-Video, AVCHD
Audio CD		Audio CD (CD-DA)
CD-R		Audio CD (CD-DA), MP3, WMA, JPEG, AVI, WMV
CD-RW		Audio CD (CD-DA), MP3, WMA, JPEG, AVI, WMV

- Only BD-RE/-R, DVD-R/-RW and CD-R/-RW discs recorded with UDF or ISO9660 format can be played back.
- This unit supports Ver 2.0 BD-ROM, Ver 3.0 BD-RE and Ver 2.0 BD-R.

Notes :

- Unfinalized BD-RE/-R, DVD-R/-RW and CD-R/-RW discs can not be played back.
- Some 8 cm BD-REs/8 cm BD-Rs cannot be played on this unit.
- When a BD-Java title is played, loading may take longer than a normal title, or some functions may perform slowly.

Unplayable discs

- Since this unit cannot support disc types, formats and file types not listed above, do not play such discs.
- Some BD-RE/BD-R, DVD-RWs/DVD-Rs or CD-Rs/CD-RWs cannot be played due to incomplete disc finalization, recording quality or physical condition of the disc, characteristics of recording device or authoring software, etc.
See the operating instructions supplied with your recording device for more information.

Color system format

- Depending on the countries, this unit conforms to either the NTSC color system for U.S.A, Canada, etc. or the PAL for Europe, Australia, China, etc.









REGION CODE

- Blu-ray Disc player and BD-ROM or DVD Video discs are assigned region codes according to the region in which they are sold. If the region codes do not match, the disc will not play.

Blu-ray Disc Region Code	Area
A	North America, Central America, South America, Korea, Japan, Taiwan, Hong Kong and South East Asia
B	Europe, Greenland, French territories, Middle East, Africa, Australia and New Zealand
C	India, China, Russia, Central and South Asia
A, B and C	All areas

DVD Region Code	Area
1	North America
2	Europe, Japan, Middle East, Egypt, South Africa, Greenland
3	Taiwan, Korea, the Philippines, Indonesia, Hong Kong
4	Mexico, South America, Central America, Australia, New Zealand, Pacific Islands, Caribbean
5	Russia, Eastern Europe, India, most of Africa, North Korea, Mongolia
6	China
ALL	All areas

Examples of playable discs :



	U.S.A.	Europe
BDs	  	 
DVDs	 	 

ENGLISH

NOTES ON COPYRIGHT

- Audio-visual material may consist of copyrighted works which must not be recorded without the authority of the owner of the copyright. Refer to relevant laws in your country.
- This product incorporates copyright protection technology that is protected by U.S. patents and other intellectual property rights. Use of this copyright protection technology must be authorized by Macrovision, and is intended for home and other limited viewing uses only unless otherwise authorized by Macrovision. Reverse engineering or disassembly is prohibited.

SYMBOL ABOUT INVALID OPERATION

- When you press a button, if the unit does not accept its operation,  appears on the TV screen.
Operations are occasionally unacceptable even if  is not displayed.

※ Invalid operation may occur as expected if :

- The region codes of the unit is different from that of the disc and playback will not be allowed.
- The parental control works.
(For details, refer to "SETTING THE PARENTAL CONTROL" on page 34.)
- BD/DVD Video operations and functions may be different from the explanations in this manual and some operations may be prohibited due to disc manufacturer's settings.

PLAYABLE FILES

- Characters except "A~Z", "a~z", "0~9", " - " may be not displayed.
- This unit supports multi-session discs. Some multi-session discs may take a long time to load and some may not be loaded at all.

■ Notes :

- For some files, it may not be possible to use certain functions during playback.
- It may not be possible to play some files, even if they have the extension of a file playable on this player.
- Files protected by DRM (Digital Rights Management) cannot be played.

■ MP3 (" .mp3")

- Sampling frequency : 44.1 kHz, 48 kHz.
- Bit rate : Up to 320 kbps.
- Fixed bit-rate files are recommended. Variable bit-rate (VBR) files are playable, but playing time may be displayed incorrectly.
- ID3 Tag is not available.
- MP3i and MP3 Pro are not available.

■ WMA (" .wma")

- Sampling frequency : 44.1 kHz, 48 kHz.
- Bit rate : Up to 192 kbps.
- WMA Tag is not available.

■ JPEG (" .jpg", " .jpeg")

- Maximum resolution : 4,272x2,848 pixels.
- JPEG format images stored in progressive format cannot be played back.

■ AVI (" .avi")

- Playable codec : Xvid
- Maximum size of image : 1920 x 1080@30 fps

■ WMV (" .wmv")

- Playable codec : WMV9
- Maximum size of image : 1920 x 1080@30 fps

CARE AND HANDLING OF DISCS

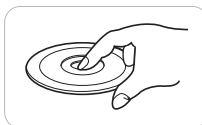

- In handling a disc, hold it carefully with edges.

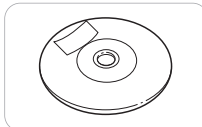

- Do not stick paper or write anything on the printed surface.

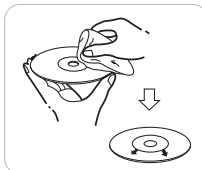

- Fingermarks and dust on the recorded surface should be carefully wiped off with a soft cloth. Wipe straight from the inside to the outside of the disc.

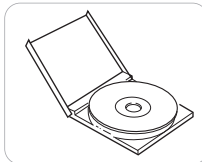

- Always keep the discs in their cases after use to protect them from dust and scratches.

- Do not use a cracked, deformed, or repaired disc. These discs are easily broken and may cause serious personal injury and apparatus malfunction.



■ Notes:

- Because the temperature inside this unit is very high, in case of no further playback of disc, unload the disc to prevent the high temperature from deforming the disc.
- Do not expose discs to direct sunlight, high humidity or high temperature for a long time.
- When loading or unloading a disc in the disc tray, always place it with the printed side up.

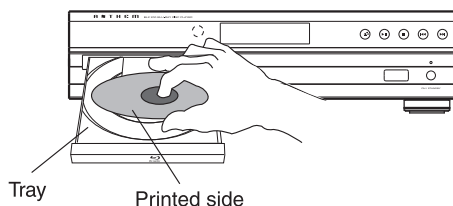

Operations

■ Before starting playback

- First set this unit as desired for optimum performance, doing the system setting procedures. (For details, refer to "System Settings" on page 29.)
- Usable discs and files for each operation/function are referred to by the icons :



VIDEO means AVI and WMV files.

PLAYING A DISC **BD DVD-V AVCHD CD**

1. Turn the power on.

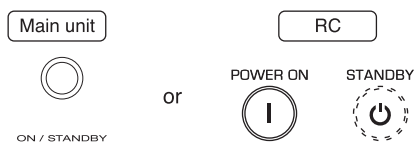

- Each time the POWER ON/STANDBY button on the front panel is pressed, the unit is turned on to enter the operating mode (the POWER ON/STANDBY indicator lights up blue) or off to enter the standby mode (the POWER ON/STANDBY indicator lights up amber).
- On the remote control, press the POWER ON button to enter the operating mode or press the STANDBY button to enter the standby mode.
- In the standby mode, the unit is connected to the AC mains and a small amount of current is retained to support operational readiness.

2. Open the disc tray to load a disc with the printed side up.

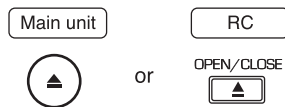

- 8 cm(3 inch) discs can be loaded on the inside circle of the tray, too.
- Depending on the disc types, it may take times to read the loaded disc.
- Then the main menu will be displayed on the TV screen.

Example :

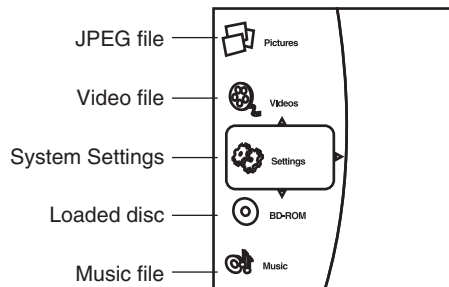

- When the Optical Disc Autoplay is set to On (default setting), playback will automatically start. (For details, refer to "Optical Disc Autoplay" on page 30.) Should this happen, ignore the step 3.

3. Press the CURSOR UP/DOWN buttons to select the disc, then press the OK button. (When the Optical Disc Autoplay is set to Off.)

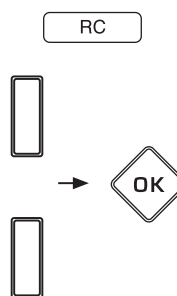

- Then playback will start.
- For some discs, the menu may be displayed first.

To start playback from the menu

BD DVD-V AVCHD

- To select the preferred item, press the CURSOR buttons and press the OK button or press the NUMERIC buttons.

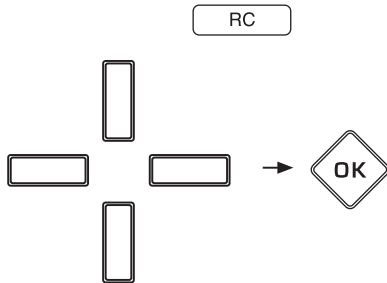

In case of use of the NUMERIC buttons on the remote control

- When selecting "3" : **3**
- When selecting "10" : **1** → **0**
- When selecting "21" : **2** → **1**
- Playback of the selected item starts.
- When the selected item contains the subitems, repeat the above step until the preferred item is selected.
- Depending on the disc, the contents of the menu and the way to operate differ.

To stop playback

BD DVD-V AVCHD CD

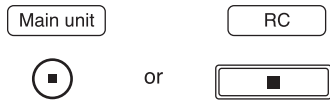

- When the STOP(■) button is pressed during playback of BD Video, DVD Video or AVCHD discs, the point at which the disc was stopped is stored in the memory. (RESUME function : "Stop" mode.)
- Press the PLAY/PAUSE (▶/||) button again, then playback will resume from this point. When the STOP(■) button is pressed again, the RESUME function will be canceled and it enters "FullStop" mode.

Note :

- For some BD Video discs which support Java applications, the RESUME function will not work.

To pause playback

BD DVD-V AVCHD CD

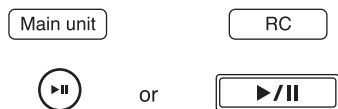

- Then the unit will be in the "Pause" mode.
- To return to normal playback mode, press this button again.

Slow playback

BD DVD-V AVCHD



- Each time the SLOW(▶) button is pressed, you can play back the disc slowly at 3 step speed.
→ Slow x 1/2 → Slow x 1/4 → Slow x 1/8
- To return to normal playback, press the PLAY/PAUSE (▶/||) button.

Frame advance playback

BD DVD-V AVCHD



- Each time the STEP(▶▶) button is pressed, the disc is advanced by one frame.
- To return to normal playback, press the PLAY/PAUSE (▶/||) button.

To skip ahead or back

BD DVD-V AVCHD CD

- During playback,

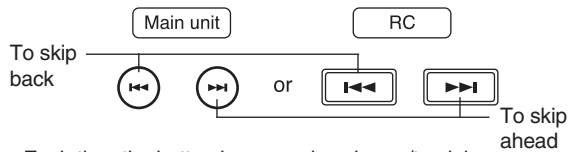

- Each time the button is pressed, a chapter/track is skipped.
- When the BACKWARD SKIP(◀◀) button is pressed once midway through a chapter/track, playback returns to the beginning of that chapter/track. When it is pressed again, a chapter/track is skipped.

Rapid playback

BD DVD-V AVCHD CD

- During playback, you can play back disc at various speeds.

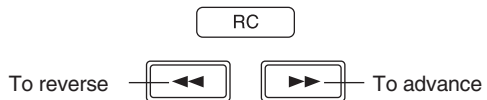

- Each time the button is pressed, the disc is advanced or reversed fast at 7 step speeds.
→ Fast x 2 → x 4 → x 8 → x 16 → x 32 → x 64 → x 128
- To return to normal playback, press the PLAY/PAUSE (▶/||) button.

Displaying disc information BD DVD-V AVCHD CD

- During playback,

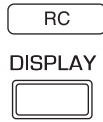

- Then the disc information is displayed on the TV screen.

Example : During playback of CD

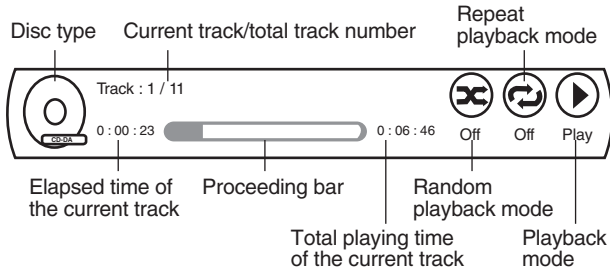

- To turn off the information, press this button.
- Depending on the disc types, the disc information differs.

Playing the desired section of disc

BD DVD-V AVCHD CD

1. During playback, press the GO TO button.



- Then the search mode is displayed on the TV screen for several seconds.
- Each time this button is pressed, the search mode is changed depending on the disc types as follows :

BD DVD-V AVCHD

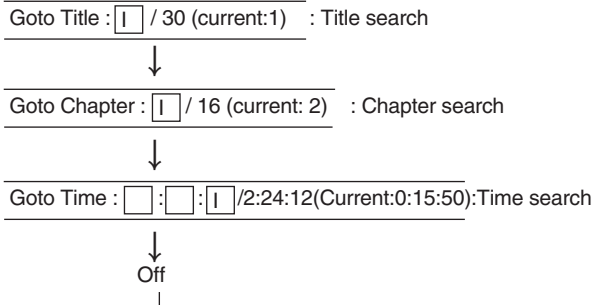

CD

Goto Track : [] / 11 (current: 1) : Track search

2. At the desired search mode, enter the number to be played, pressing the NUMERIC buttons.

■ When entering title, chapter, track number

Examples :

For "3" : 3

For "11" : 1 → 1

■ When entering the elapsed time

You can play a disc from the desired by specifying the elapsed time from the beginning of the current title/disc.

Examples :

For "3 min. 15 sec." : 3 → 1 → 5

For "1 hour. 59 min. 35 sec." :

1 → 5 → 9 → 3 → 5

■ When clearing the numbers entered

- Press the CURSOR LEFT/RIGHT buttons to select the number to be cleared, then press the CLEAR button.

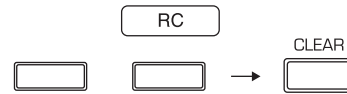

- Then the selected number will be cleared.

3. Press the OK button.



- Then playback will start from the selected section.

■ Notes:

- If the disc does not contain the number you entered, search playback will not work.
- Depending on the disc, search playback will not work or may work differently.

Playing repeatedly **BD DVD-V AVCHD CD**

- You can play a current title, chapter, disc or track repeatedly.
- During playback of the desired chapter/track, press the REPEAT button.

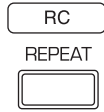

- Each time this button is pressed, the repeat mode changes depending on the disc types as follows :

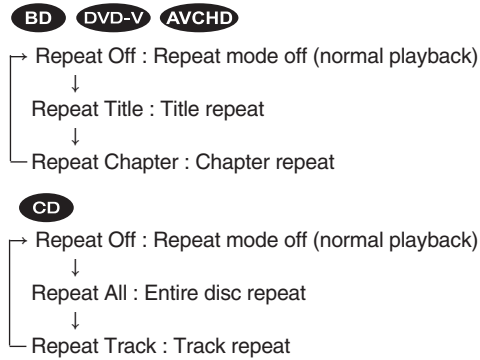

- **Note :**
- For some BD Video discs which support Java applications, the repeat playback will not work.

Playing a specific section repeatedly

BD DVD-V AVCHD CD

- You can play a specific section within a title or track repeatedly.

1. During playback at the beginning of the section, press the REPEAT A-B button.

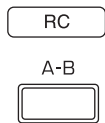

- Then "Repeat A-" is displayed on the TV screen.

2. At the end of the section, press the REPEAT A-B button again.

- Then "Repeat A-B" is displayed and the section between points A and B is played back repeatedly.
- To return to normal playback, press the REPEAT A-B button repeatedly until "Repeat Off" is displayed.

- **Note :**
- For some BD Video discs which support Java applications, the REPEAT A-B function will not work.

Playing in random order **CD**

- You can play the tracks in random order.
- During playback, press the RANDOM button.



- Each time this button is pressed, the random mode changes as follows :

Random Off : Random mode off (normal playback)



Random On : Random playback

The tracks on the disc are played back in random order.

Operations using disc menu, top menu, and Pop-up menu

Many of BD Video and DVD Video disc contains disc menu, top menu or pop-up menu which guides you through the available functions in the disc.

- **Note :**
- Contents of menus and corresponding menu operations may vary among discs. (For details, refer to the disc manual.)

Using the disc menu. **BD DVD-V AVCHD**

1. During playback, press the disc menu.



- Then the disc menu is displayed on the TV screen if present on the disc.

2. Press the CURSOR buttons to select the desired item, then press the OK button.

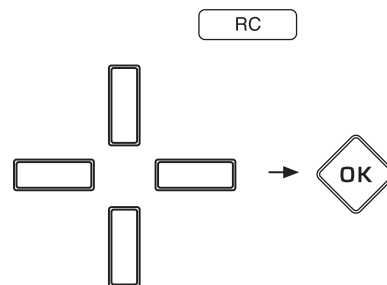

- Then the selected item is played back.

■Using the top menu. **DVD-V AVCHD**

1. During playback, press the POPUP MENU button.



- Then the top menu is displayed on the TV screen if present on the disc.

2. Press the CURSOR buttons to select the desired item, then press the OK button.

- Then the selected item is played back.

■Using the pop-up menu. **BD**

- This is a special feature available for some BD video. When you press the POPUP button, a menu pops out on the TV screen while the contents are still played back.

1. During playback, press the POPUP MENU button.

- Then the pop-up menu is displayed if present on the disc.

2. Press the CURSOR buttons to select the desired item, then press the OK button.

- Then the selected item is played back.

3. Press the POPUP button to exit.

- The pop-up menu will automatically disappear for some discs.

Switching the audio soundtrack

BD DVD-V AVCHD

For discs on which multiple audio streams are recorded, audio streams can be switched during playback. Also use this procedure to switch the secondary audio for BD video on which secondary audio is recorded.

- It is possible to change the audio language to a different language from the selected one at the System Settings. (For details, refer to “SETTING THE LANGUAGE” on page 33.)

1. During playback, press the AUDIO button.



- Then the audio stream information is displayed for several seconds.

Example : BD Videos on which secondary audio is recorded.

Current audio stream/total number of recorded audio streams

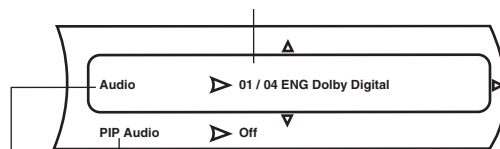

Secondary audio : Only selectable for BD Videos on which secondary audio is recorded.
(Primary) audio

2. Press the CURSOR RIGHT button.

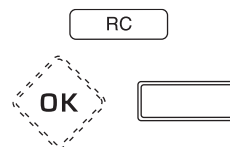

- Then the audio stream menu is displayed.
- To switch the secondary audio, press the CURSOR UP/DOWN buttons to select the PIP Audio, then press the CURSOR RIGHT button.

3. Press the CURSOR UP/DOWN buttons to select the desired audio stream, then press the OK button.

- Then the selected audio stream will be switched.

■Note:

- When the primary and the secondary audio streams are all switched, they will be mixed and heard together. If confused, set the PIP Audio to Off to switch off the secondary audio stream.

Switching the subtitles **BD** **DVD-V** **AVCHD**

For discs on which multiple subtitles are recorded, the subtitles can be switched during playback. Also use this procedure to switch the secondary subtitle for BD Video on which secondary subtitle is recorded.

- It is possible to change the subtitle language to a different language from the selected one at the System Settings. (For details, refer to "SETTING THE LANGUAGE" on page 33.)

1. During playback, press the SUBTITLE button.

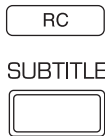

- Then the subtitle information is displayed for several seconds.

Example : BD Videos on which secondary subtitle is recorded.

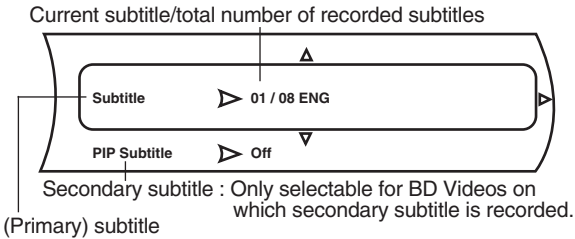

2. Press the CURSOR RIGHT button.

- Then the subtitle menu is displayed.
- To switch the secondary subtitle, press the CURSOR UP/DOWN buttons to select the PIP Subtitle, then press the CURSOR RIGHT button.

3. Press the CURSOR UP/DOWN buttons to select the desired subtitle, then press the OK button.

- Then the selected subtitle will be displayed.
 - To switch off the subtitle, select the Off.
- Note:**
- When the primary and the secondary subtitles are all switched, both will be displayed on the TV screen. If confused, set either of subtitles to Off.

Switching the camera angles **BD** **DVD-V**

- For discs on which multiple angles are recorded, the angles can be switched during playback.

Note:

- You can switch the camera angle at only the scene that have been shot simultaneously from multiple camera angles.

1. During playback at the scene recorded from multiple camera angles, press the ANGLE button.

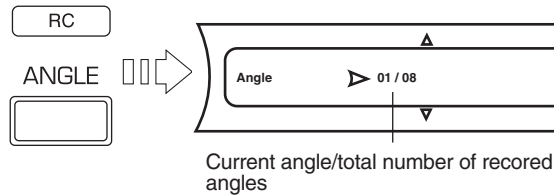

- Then the angle information is displayed for several seconds.

2. Press the CURSOR RIGHT button.

- Then the angle menu is displayed.

3. Press the CURSOR UP/DOWN buttons to select the desired angle, then press the OK button.

- Then the scene recorded from the selected angle will be displayed.

Adjusting the brightness of the fluorescent display

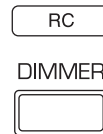

- Each time this button is pressed, the brightness of the fluorescent display changes as follows :

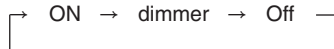

ENJOYING BONUSVIEW OR BD-LIVE

This unit is compatible with additional functions of BD Video, BONUSVIEW (BD-ROM Profile 2.0) and BD-LIVE. For BD Video discs compatible with BONUSVIEW, the functions of Picture in Picture and Virtual Package are available.

For BD-LIVE compatible discs, you can enjoy a variety of functions via the internet in addition to the BONUSVIEW functions.

Virtual Package/BD-LIVE data is saved in Local Storage (USB memory device connected to this unit).

To enjoy these functions, connect a USB memory device (minimum 1 GB capacity (2 GB or more recommended)) supporting FAT 32 and USB 2.0 High Speed (480 Mbit/s) to the USB connector. (For details, refer to "USB CONNECTOR" on page 12.)

- If there is insufficient storage space, the data will not be copied/downloaded. Delete unneeded contents or use a new USB memory device.
- If a USB memory device containing other contents (previously recorded) is used, the video and audio may not play back properly.
- If the USB memory device is disconnected from this unit during playback of Virtual Package/BD-LIVE contents, playback of the disc will stop.
- Some time may be required for the contents to load (read/write).

■Notes :

- It may not be possible to use the BD-LIVE functions if there is insufficient space on the USB memory device. In this case, refer to "Erase Blu-ray Storage?" on page 29 for erasing the Virtual Package contents and the BD-LIVE contents in the USB memory device.
- Operation of USB memory devices is not guaranteed.
- Do not use a USB extension cable when connecting a USB memory device to the USB connector.

Playing secondary video(Picture in Picture)

BD Video that includes secondary video and audio compatible with Picture in Picture can be played back will secondary video and audio simultaneously as a small video in the corner.

- To listen to secondary audio or to display secondary subtitle, refer to "Switching the audio soundtrack" or "Switching the subtitles" on page 21.

■Note :

- You can call up the secondary video at only the scene that contains the secondary video. (For details on PIP function of your disc, refer to the disc manual.)

1. During playback at the scene that contains the secondary video, press the PIP button.

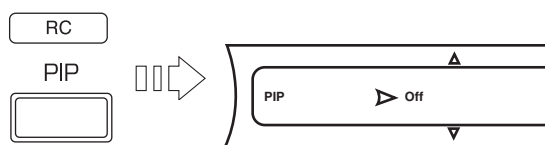

- Then the PIP setting menu is displayed for several seconds on the TV screen.

2. Press the CURSOR RIGHT button to enter the PIP mode menu.

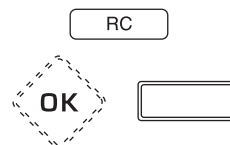

3. Press the CURSOR UP/DOWN buttons to select the secondary video, then press the OK button.

- Then the secondary video will be displayed.

Example :

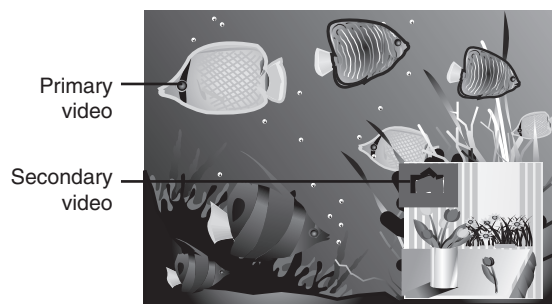

Virtual Package

For BD Video discs compatible with Virtual Package, contents are copied from the discs or internet to local storage. It is automatically copied to the local storage prior to playback. You can enjoy a variety of additional functions including secondary video, secondary audio, subtitles, movie trailer, etc.

- The playback methods vary depending on the disc. (For details, refer to the disc manual.)

BD-LIVE

In this unit, a variety of contents with interactive functions are available through BD-LIVE compatible BD discs by connecting to the internet. You can enjoy the download of bonus features such as latest movie trailers to the USB memory device, communication compatible BD-J interactive games, etc.

- The available functions differ depending on the disc.

■Notes :

- Regarding playback method of BD-LIVE contents, etc., perform the operations in accordance with the instructions in the BD disc manual.
- To enjoy BD-LIVE functions, perform the broadband internet connection and communication settings. (For details, refer to "CONNECTING TO NETWORK" on page 9 and "SETTING THE NETWORK" on page 35.)
- Regarding the setup to restrict access to BD-LIVE contents, refer to "BD-Live Internet Access" on page 30.)

PLAYING FILES **MP3** **WMA** **JPEG** **VIDEO**

• You can play music files such as MP3 and WMA, picture files such as JPEG and video files such as AVI and WMV recorded onto a CD-R/-RW or a USB memory device.

1. In the stop mode, load a disc or insert a USB memory into the USB connector.

• Then the music and picture file symbols, etc are displayed on the main menu.

Example : When a USB memory is inserted.

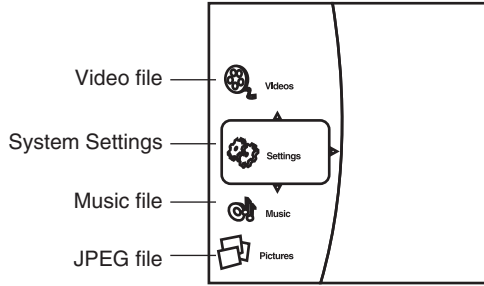

2. CURSOR UP/DOWN buttons to select the type of file to be played, then press the CURSOR RIGHT button.

Example : When the Music file is selected

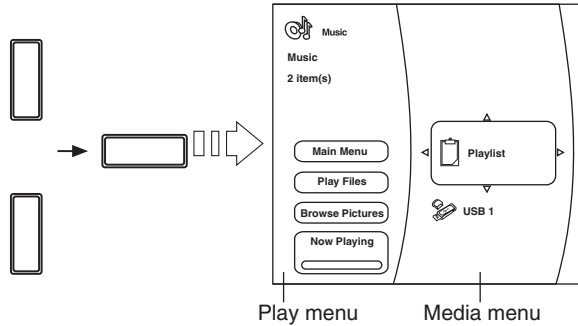

• Then the play menu of the selected type of file is displayed.

3. Press the CURSOR buttons to select the desired media in the media menu, then press the CURSOR RIGHT button.

• Then the folder and files recorded onto the selected media are displayed.

Notes:

- Even if a CD-R/CD-RW or a USB memory device contains a mix of music, picture and video files, you will only be able to browse the selected type of files (music, picture or video).
- When there are no files to be played onto the selected media or folder, " ⊗ Empty " will be displayed.

4. Select the desired file using the CURSOR buttons, then press the OK button or the CURSOR RIGHT button.

• Then the corresponding dialog box is displayed depending on whether the Playlist is selected as a media or not as follows.

• When selecting the Playlist

• When selecting the Optical Disc or the USB 1

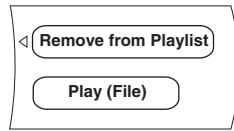

Note:

• When the JPEG file is selected as a type of file to be played, the "Play(File)" cannot be selected.

5. Press the CURSOR UP/DOWN buttons to select the desired item in the dialog box, then press the OK button.

When selecting the "Remove from Playlist"

- The selected file is cleared in the playlist.
- Repeat the above steps 4 and 5 until other files are cleared.

When selecting the "Add To Playlist"

- The selected file is added in the playlist.
- Repeat the above steps 4 and 5 until other files are added.

Note :

• When a disc is unloaded or the USB memory is disconnected, the files are all cleared in the playlist.

When selecting the "Play (File)"

• Only the selected file will be played (and the file information will be displayed on the TV screen when playing a music file).

Example : When playing a music file

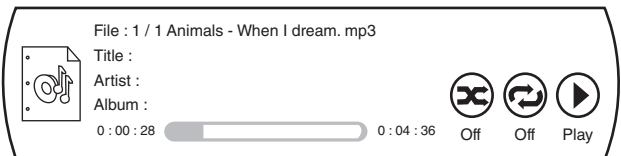

Note:

• To play JPEG files, select the "Play Files" in the play menu.

Selecting an item in the play menu

MP3 WMA JPEG VIDEO

- The items listed in the play menu may vary depending on the operation status and the selected media, etc.

■Note:

- During playback of file, press the STOP(■) button (or the HOME MENU button) to display the play menu, etc.
- In the stop mode, press the CURSOR UP/DOWN buttons to select an item in the play menu, then press the OK button.

■When selecting the “Main Menu”

- The main menu will be returned to.

■When selecting the “Play Files”

- Press the CURSOR UP/DOWN buttons to select the desired play mode in the play menu, then press the OK button. Then playback will start according to the selected play mode.

■Notes:

- When playing JPEG files, each file is displayed for the time interval you specified.
- The selectable play mode may vary depending on the operation status and the selected media, etc.

■When selecting the “Browse Pictures” or the “Browse Music”

- The JPEG file or the music file will be changed to as the type of file to be played.

■When selecting the “Add all to playlist”

- All the files are added in the playlist.

■When selecting the “Remove all from playlist”

- All the files are cleared in the playlist.

■When selecting the “Previous folder”

- Each time this item is selected, the previous folder or the previous menu will be returned to.

■When selecting the “Now Playing”

- The playback status for music files is displayed.

To stop playback

MP3 WMA JPEG VIDEO

Main unit

RC



or



- Then the playback will be stopped and the play mode, etc. will be displayed.

To pause playback

MP3 WMA JPEG VIDEO

Main unit

RC



or



- Then the unit will be in “Pause” mode.
- To return to normal playback mode, press this button again.

Slow playback

VIDEO

RC

SLOW



- Each time the SLOW (▶) button is pressed, you can play back the video files slowly at 3 step speed.

→ Slow x 1/2 → Slow x 1/4 → Slow x 1/8

- To return to normal playback, press the PLAY/PAUSE (▶/||) button.

To specify the time interval

JPEG

- During playback,

RC

SLOW



- Each time the SLOW (▶) button is pressed, you can specify the time interval to display the JPEG file as follows :

→ 5 seconds → 10 → 15 → 30

Frame advance playback VIDEO



- Each time the STEP (II) button is pressed, the video file is advanced by one frame.
- To return to normal playback, press the PLAY/PAUSE (▶/II) button.

To skip ahead or back MP3 WMA JPEG VIDEO

- During playback,

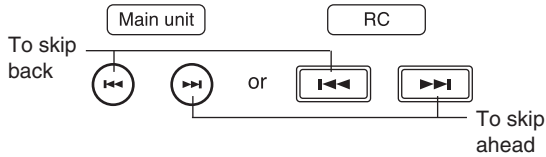

- Each time the button is pressed, a file is skipped.
- When the BACKWARD SKIP (◀◀) button is pressed once midway through a MP3/WMA/VIDEO file, playback returns to the beginning of that file. When it is pressed again, a file is skipped.

Rapid playback MP3 WMA JPEG VIDEO

- During playback, you can play back files at various speeds depending on the type of file as follows :

MP3 WMA VIDEO



- Each time the button is pressed, the file is advanced or reversed fast at 7 step speeds.

→ Fast x2 → x4 → x8 → x16 → x32 → x64 → x128 →

- To return to normal playback, press the PLAY/PAUSE (▶/II) button.



- Each time the FORWARD SEARCH (▶▶) button is pressed, the time interval to display is shortened as follows :

→ 5 seconds → 2 → 1 → No Delay →

Displaying file information JPEG VIDEO

- During playback,

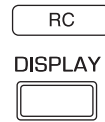

- Then the file information is displayed on the TV screen.

Example : During playback of video file.

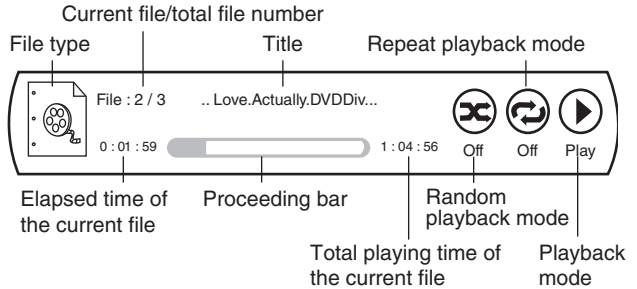

- To turn off the information, press this button.
- Depending on the file types, the file information differs.
- During playback of music files, the file information is still displayed without pressing this button.

Playing the desired section of file

MP3 WMA VIDEO

1. During playback, press the GO TO button.

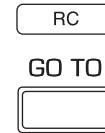

- Then the search mode is displayed on the TV screen for several seconds.
- Each time this button is pressed, the search mode is changed as follows :

Goto File : / 81 (current: 1) : File search



Goto Time : : : / 0:02:29 (Current: 0:00:39) : Time search

2. At the desired search mode, enter the number to be played, pressing the NUMERIC buttons.

■ When entering file number

Examples :

For "3" : 3

For "11" : 1 → 1

Continued

■When entering the elapsed time

You can play from the desired by specifying the elapsed time from the beginning of the current file.

Examples :

For "3 min, 15 sec." : → →

For "1 hour, 59 min, 35 sec." :

→ → → →

■When clearing the number entered

• Press the CURSOR LEFT/RIGHT buttons to select the number to be cleared, then press the CLEAR button.

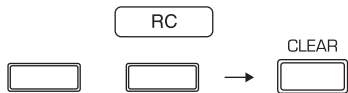

3. Press the OK button.



• Then the playback will start from the selected section.

■Notes :

- If the media does not contain the number you entered, search playback will not work.
- Depending on the files, search playback will not work or may work differently.

Playing repeatedly **MP3** **WMA** **JPEG** **VIDEO**

- You can play a current file or all files repeatedly.
- During playback of the desired file, press the REPEAT button.

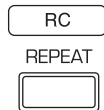

• Each time this button is pressed, the repeat mode changes depending on the file types as follows :

MP3 **WMA** **VIDEO**

- Repeat Off : Repeat mode off (normal playback)
- ↓
- Repeat All : All file repeat
- ↓
- Repeat File : File repeat

JPEG

- Repeat Off : Repeat mode off (normal playback)
- ↓
- Repeat All : All file repeat

Playing in random order **MP3** **WMA** **VIDEO**

- You can play the files in random order.
- During playback, press the RANDOM button.

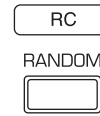

- Each time this button is pressed, the random mode changes as follows :

Random Off : Random mode off (normal playback)



Random On : Random playback

The files are played back in random order.

To change the effect on displaying pictures

JPEG

- You can display the JPEG files at the slide show options you select.

1. During playback, press the POPUP MENU button.

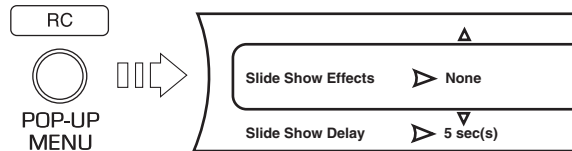

- Then the Slide Show menu is displayed for several seconds.

2. Press the CURSOR UP/DOWN buttons to select the desired item, then press the CURSOR RIGHT button.

- Then the selected item menu is displayed.

3. Press the CURSOR UP/DOWN buttons to select the desired option, then press the OK button.

■When selecting the Slide Show Effects

- You can select the desired of different display modes as follows :

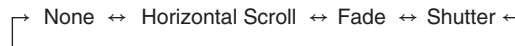

■When selecting the Slide Show Delay

- You can select the desired of different time intervals to display the JPEG files as follows :

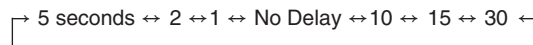

Playing both the music files and the JPEG files simultaneously **MP3** **WMA** **JPEG**

1. During playback of music files, press the OK button.
 - Then the play menu, etc are displayed.
2. In the play menu, press the CURSOR UP/DOWN buttons to select the "Browse Pictures", then press the OK button.
 - Then you can browse the JPEG files to be played.
3. Select the some JPEG files to be played and play them in the desired play mode.
 - Then you can see the JPEG files while listening to the music files.
 - While playing both the music files and the JPEG files, the playback controls are effective for the JPEG files only.

■ To control the music files

 1. Press the STOP(■) button to stop the playback of the JPEG files.
 - Then the play menu, etc. will be displayed.
 2. Press the CURSOR UP/DOWN buttons to select the "Now Playing" in the play menu, then press the OK button.
 - Then the music file information is displayed and you can control the music files.

System Settings

- The OSD (On-Screen Display) menu enables various audio/visual settings and adjustments.

1. In the stop mode, press CURSOR UP/DOWN buttons to select “Settings” in the main menu, then press the CURSOR Right button.

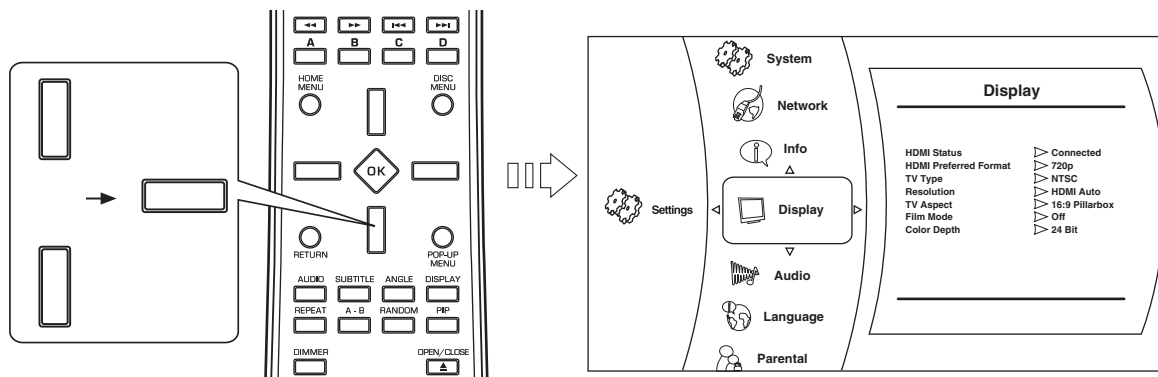

- During playback of BD Video, DVD Video or CD disc, if the STOP(■) button or the HOME MENU button is pressed, then the main menu will be displayed.
- During playback of music or video files, if the STOP(■) button or the HOME MENU button is pressed, then the previous menu will be displayed, in this case, press the RETURN button repeatedly until the main menu is displayed.
- During playback of JPEG files, if the HOME MENU button is pressed, then the main menu will be displayed.

2. Press the CURSOR UP/DOWN buttons to select the desired setting category, then press the CURSOR RIGHT button.

- You can select the desired of various setting categories as follows :

System : See “SETTING THE SYSTEM” on page 30.
 Network : See “SETTING THE NETWORK” on page 35.
 Info : You can check the system information on this unit.
 Display : See “SETTING THE DISPLAY” on page 31.
 Audio : See “SETTING THE AUDIO” on page 32.
 Language : See “SETTING THE LANGUAGE” on page 33.
 Parental : See “SETTING THE PARENTAL CONTROL” on page 34.

■ **Note :**

- Because the setting operation for Parental and Network differs, follow their own procedures.

3. Press the CURSOR UP/DOWN buttons to select the desired setting item, then press the CURSOR RIGHT button.

- Then the selected item’s option menu will be displayed.

4. Press the CURSOR UP/DOWN buttons to select the desired option, then press the OK button to confirm your selection.

- Then the previous screen will be displayed.
- To go back to the previous screen, press the CURSOR LEFT button or the RETURN button.

SETTING THE SYSTEM

- For how to select the setting items and options, refer to “System Settings” on page 29.
- Settings with* are the default.

ENGLISH

Setting items	Options
<p>Optical Disc AutoPlay Set whether to automatically play a disc or not when loading it or turning on the Power under the condition that it is loaded.</p>	<p>On* : Starts play automatically. Off : Turns off the autoplay.</p>
<p>BD-Live Internet Access Set the access restriction to BD-LIVE contents</p>	<p>Limit Access : Allows only the BD disc with owner certification to access contents from a BD-LIVE website. Always Allow Access* : Allows all BD-LIVE discs to access contents from BD-LIVE websites. Prohibit Access : Prohibit all BD-LIVE discs from accessing contents from BD-LIVE websites.</p> <p>■Notes : • The available functions differ depending on the disc. • Regarding playback method of BD-LIVE contents, etc., perform the operations in accordance with the instructions in the BD-LIVE disc manual. • To enjoy BD-LIVE functions, perform the broadband internet connection and communication settings. (For details, refer to “CONNECTING TO NETWORK” on page 9 and “SETTING THE NETWORK” on page 35.)</p>
<p>BD-Live Storage (USB) Set whether BD-LIVE contents is store into the USB memory device or the internal memory of this unit.</p>	<p>Internal (~ MB Free) Stores the data for updating, etc. into the internal memory of this unit. USB1 (~ GB Free)* Stores the BD-LIVE contents into the USB memory device.</p> <p>■Note : • Only when the USB memory device is connected to this unit, “USB1” can be selected.</p>
<p>Screen Saver Duration Set the period of time to activate screen saver function. A TV screen may be burned out if a static picture is displayed for a long time in the stop mode, etc.. To prevent this, the unit automatically activate the screen saver function if a static picture is displayed over the period of time you set.</p>	<p>Off : Inactivates screen saver function. 5*/10/20/30 Minutes Activates screen saver function if a static picture is displayed over the period of time you set.</p> <p>■Note : • To inactivates screen saver function, press any button.</p>
<p>Erase Blu-ray Storage? Erase the Virtual Package and BD-LIVE contents stored into the USB memory storage.</p>	<p>1. Perform the steps 1~3 in “System Settings” procedure on page 29 to select “Erase Blu-ray Storage?” or “Reset Settings” on the system menu. 2. Press the OK button. Then the dialog window will be displayed.</p>
<p>Reset Settings Reset all settings to the factory default except the Parental settings, etc.</p>	<p>3. Press the CURSOR LEFT/RIGHT buttons to select “OK”, then press the OK button.</p>

SETTING THE DISPLAY

- For how to select the setting items and options, refer to “System Settings” on page 29.
- Settings with* are the default.

Setting items	Options
<p>TV type Set the video signal format depending on that of your TV and disc.</p>	<p>NTSC : Select this when the video signal format of your TV and the discs is NTSC color system for U.S.A., Canada, etc..</p> <p>PAL : Select this when the video signal format is PAL color system for Europe, Australia, China, etc..</p> <p>■ Note : • If the color system of this unit is different from that of your TV and the discs, the screen may be somewhat hard too see or the picture quality may be poor. Only in this case, set the video signal format to another.</p>
<p>Resolution Set the resolution of the Component and HDMI video signal</p>	<p>HDMI Auto : HDMI video resolution will be selected automatically depending on the HDMI-compatible TV.</p> <p>1080p : Outputs 1080 lines of progressive video. 1080i : Outputs 1080 lines of interlaced video. 720p : Outputs 720 lines of progressive video. 480p : Outputs 480 lines(NTSC)(or 576 lines(PAL)) of progressive video. 480i : Outputs 480 lines(NTSC)(or 576 lines(PAL)) of interlaced video.</p> <p>• For details on Resolution settings, refer to “Video output resolution” on page 10.</p>
<p>TV Aspect Set the picture size according to aspect ratio of your TV</p>	<p>16:9 Wide* : Select this when a wide-screen TV is connected. Discs recorded in wide-screen format is played back over the entire TV screen.</p> <p>16:9 Pillarbox : When playing back 4:3 images, the picture is displayed in the center of the 16:9 screen with a 4:3 aspect ratio.</p> <p>4:3 Pan and Scan : Select this to play back the discs recorded in wide-screen format with 4:3 TV in the pan and scan mode (with the sides of the picture cut off). Discs which are not specified for pan and scan are played back in the letter box mode.</p> <p>4:3 Letterbox : Select this to play back the discs recorded in wide-screen format with 4:3 TV in the letter box mode (with black strips at the top and bottom).</p>
<p>Film Mode Set whether to output 1080/24p video signals from HDMI OUT when playing film-based materials (24 frame) on BD discs.</p>	<p>On : Select this to output 1080/24p video signals from HDMI OUT when playing film based materials (24 frame).</p> <p>Off* : Select this when playing a materials other than film based materials (24 frame).</p> <p>■ Notes : • 1080/24p video signals cannot be output from video OUTs other than HDMI OUT. • 1080/24p video signals can be output when the following conditions are met. - HDMI OUT is connected to TV compatible with 1080/24p video signals. - Resolution is set to HDMI Auto or 1080p.</p>
<p>Color Depth Set whether to output the HDMI video signal with the color depth effect or not.</p>	<p>36 Bit : Select this to output the HDMI video signal with the 36 Bit color depth to TV which supports 36 Bit HDMI deep color.</p> <p>30 Bit : Select this to output the HDMI video signal with the 30 Bit color depth.</p> <p>24 Bit* : Select this to output the HDMI video signal without the color depth effect to TV which does not support HDMI deep color.</p> <p>■ Notes : • For details on HDMI deep color which TV supports, refer to the operating instructions of TV. • If color depth setting is different from that which TV supports, picture may flicker or be displayed abnormally. Should this happen, first make (composite) video connection between this unit and TV, and select the (composite) VIDEO as an input source on the TV to display the setting menu, then set the Color Depth correctly.</p>

SETTING THE AUDIO

- For how to select the setting items and options, refer to “System Settings” on page 29.
- Settings with* are the default.

ENGLISH

Setting items	Options
<p>PCM Downsampling Set the maximum sampling frequency for the PCM signals output from the OPTICAL/COAXIAL DIGITAL OUTs.</p>	<p>Off : Outputs audio signals with no conversion. 96 kHz : Outputs audio signals at 96 kHz sampling frequency. 48 kHz* : Outputs audio signals at 48 kHz sampling frequency.</p> <p>■ Note :</p> <ul style="list-style-type: none"> • When the A/V amplifier does not support LPCM at higher sampling frequency, no sound or a loud sound may result. Should this happen, set it to lower sampling frequency.
<p>Digital Output Set the audio format for the digital audio signals output from the HDMI OUT or the OPTICAL/COAXIAL DIGITAL OUTs depending on what audio format A/V amplifier supports.</p>	<p>PCM Stereo*/Bitstream HD/Bitstream Legacy/Bitstream Mixed/PCM 5.1 / PCM 7.1/Off.</p> <ul style="list-style-type: none"> • For details on the digital audio signals output from the HDMI OUT or the OPTICAL/COAXIAL DIGITAL OUTs depending on Digital Output settings, refer to “Audio output signals” on page 11. • When the Digital Output is set to Off, no digital audio signals will be output from the HDMI OUT or the OPTICAL/COAXIAL DIGITAL OUTs.
<p>Dynamic Range Control Set whether to compress the dynamic range between the loudest and softest sounds when Dolby Digital, Dolby Digital Plus or Dolby TrueHD audio is played back.</p>	<p>On : Turns on the dynamic range compression to hear low sounds easier. Off* : Turns it off. Auto : When Dolby TrueHD audio is played back, the dynamic range is automatically adjusted.</p>

SETTING THE LANGUAGE

- For how to select the setting items and options, refer to “System Settings” on page 29.
- Settings with* are the default.

Setting items	Options
OSD Set the language for unit's OSD (On-Screen Display)	English*/French/Spanish/Italian/German/Russian
Menu Set the language for disc menu or pop-up menu.	Auto*: Selects the language given priority in the disc. English/French/Spanish/Italian/German/Portuguese/ - - - - - /Urdu/ Vietnamese/Yoruba
Audio Set the language for audio.	Auto*: Selects the language given priority in the disc. English/French/Spanish/Italian/German/Portuguese/ - - - - - /Urdu/ Vietnamese/Yoruba
Subtitle Set the language for subtitle.	Off* : Displays no subtitles. English/French/Spanish/Italian/German/Portuguese/ - - - - - /Urdu/ Vietnamese/Yoruba

■ **Notes :**

- Depending on the discs, it may not be possible to change to the selected language.

ENGLISH

SETTING THE PARENTAL CONTROL

The parental control allows you to set a limit, which prevents your children from viewing inappropriate materials. If the ratings exceed the levels you set, playback will be stopped, or inappropriate scenes such as violent scenes can be cut or replaced with other scenes depending on the disc type.

■Notes :

- When you set the Parental Level low, some discs may not be played at all, in this case, set the Parental Level higher or the parental control to Off.
- All discs may not respond to the Parental Level setting. Make sure this function works with your disc.

1. Perform the steps 1 and 2 in “System Settings” procedure on page 29 to select the Parental.

- When the Parental Control is set to On, the parental password entry screen appears as follows.

- In this case, press the NUMERIC buttons to enter the 4-digit numbers, press the CURSOR buttons to select “OK” and press the OK button.
- Then the Parental menu will be displayed.

■Note :

- Do not forget the password. When you enter the password for the first time or if you forgot your password, enter “3308” as a factory setting.

2. Press the CURSOR UP/DOWN buttons to select the setting item, then press the CURSOR RIGHT button.

- Then the selected item’s option menu will be displayed.

When selecting the Parental Control or the Parental Level

■When selecting the Parental Control

- Off* : Parental Control is inactive; all discs are played back.
 On : Parental Control restricts playing discs according to parental level you set.

■When selecting the Parental Level

- 1[Kid Safe]* : Suitable for children.
 2[G] : General audience.
 3[PG] : Parental guidance suggested.
 4[PG-13] : Unsuitable for children under 13.
 5[PG-R] : Parental guidance recommended.
 6[R] : Restricted; under 17 requires accompanying parent or adult guardian.
 7[NC-17] : No one under 17 admitted.
 8[Adult] : Discs of any grades (adult/general/children) can be played back.

- The lower the level value, the stricter the limitation.

3. Press the CURSOR UP/DOWN buttons to select the desired option, then press the OK button to confirm your selection.

- Then the previous screen will be displayed.

When selecting the Parental Password

- Then the new parental password entry screen appears.

3. Press the NUMERIC buttons to enter the new 4-digit numbers, press the CURSOR buttons to select “OK” and press the OK button.

- Then the parental password entry screen for confirmation appears.

4. Perform the above step 3.

- Then the new password will be changed to and the previous screen will be displayed.

SETTING THE NETWORK

- To access BD-LIVE contents from websites, you should connect this unit to the internet and set the communication settings. (For details, "CONNECTING TO NETWORK" on page 9.)
- When you set the communication setting manually, the following information of the connected router or modem is required. Confirm the information prior to the setting : IP address, Subnet mask, Gateway, Primary DNS and Secondary DNS.

1. Perform the steps 1 and 2 in "System Settings" procedure on page 29 to select the Network.

- Then the network setting menu will be displayed.

Wired :

Configures network settings depending on your internet environment, etc. when connecting to the internet.

Network Test :

Detects the internet connection and automatically configures the network settings by the DHCP server function of the router or modem.

■Note :

- When IP Mode is set to Off, Network Test cannot be selected.

2. Press the CURSOR UP/DOWN buttons to select the network configuration mode, then press the OK button.

- When selecting the Network Test, see page 36.

When selecting the Wired

Then the IP Settings menu will be displayed as follows :

IP Settings	
Link Status	▶ Link Up
MAC Address	00:23:03:00:50:b4
IP Mode	▶ Dynamic
IP Address	192.168.1.110
Subnet Mask	255.255.255.0
Gateway	192.168.1.1
Primary DNS	168.126.63.1
Secondary DNS	0.0.0.0
<input type="button" value="Apply"/> <input type="button" value="Cancel"/>	

3. Press the CURSOR RIGHT button to display the IP Mode.

Off:

Disables this unit's LAN capabilities.

Manual :

Configures network settings manually.

Dynamic (default setting) :

Automatically configures the network settings by the DHCP server function of the router or modem.

■Note :

- Select the Manual only when the DHCP server function of the router or modem cannot be used for the automatic configuration.

4. Press the CURSOR UP/DOWN buttons to select the desired IP Mode, then press the OK button.

■When selecting the Manual

- You can select IP Address, Subnet Mask, Gateway, Primary DNS and Secondary DNS to configure them manually.
- On the IP Settings menu, "Link Status" and "Mac Address" display the corresponding information merely.

- ① Press the CURSOR UP/DOWN buttons to select the desired option, then press the OK button. Then the New Value entry screen will be displayed.

Example : When selecting IP Address

Please enter a new IP Address.	
Valid range of each segment is 0 to 255.	
Current value	▶ 192.168.1.110
New Value	<input type="text" value="."/> <input type="text" value="."/> <input type="text" value="."/> <input type="text" value="."/>
▼	
<input type="button" value="OK"/>	<input type="button" value="Cancel"/>

- ② Enter the new value pressing the NUMERIC buttons, then press the CURSOR buttons to select "OK" and press the OK button.
- ③ Repeat the above steps ① and ② until other new values are all entered.

Continued

5. Press the CURSOR UP/DOWN buttons to select "Apply", then press the OK button.

■ When selecting the Manual or the Dynamic

- Then the network test is automatically performed and the result is displayed.
- Press the OK button to confirm the test result. Then the network menu will be displayed.

■ When selecting the Off

- The values for IP Address, Subnet Mask, Gateway, Primary DNS and Secondary DNS are all cleared.

When selecting the Network Test

- Then the network test is automatically performed and the result is displayed.
- Press the OK button to confirm the test result. Then the network menu will be displayed.

Definition Of Terms

AVCHD(Advanced Video Codec High Definition)

The AVCHD is a high definition(HD) digital video camera recorder format recording high-definition onto certain media by using highly efficient codec technologies.

- “AVCHD” and the “AVCHD” logo are trademarks of Panasonic Corporation and Sony Corporation.

BDAV

BDAV(Blu-ray Disc Audio/Visual, BD-AV) refers to one of the application formats used for writable Blu-ray discs such as BD-R, BD-RE, etc. BDAV is a recording format equivalent to DVD-VR(VR mode) of the DVD specifications.

BD-J application

The BD-ROM format supports Java for interactive functions. “BD-J” offers content providers almost unlimited functionality when creating interactive BD-ROM titles.

- Java and all Java-based trademarks and logos are trademarks or registered trademarks of Sun Microsystems, Inc. in the U.S. and other countries.

BD-LIVE

A variety of interactive content is available from BD-LIVE compatible Blu-ray discs via the internet.

- “BD-LIVE” logo is trademark of Blu-ray Disc Association.

BDMV

BDMV(Blu-ray Disc Movie, BD-MV) refers to one of the application formats used for BD-ROM which is one of the Blu-ray Disc specifications. BDMV is a recording format equivalent to DVD-video of the DVD specification.

BD-R

A BD-R(Blu-ray Disc Recordable) is a recordable, write-once Blu-ray Disc. Since contents can be recorded and cannot be overwritten, a BD-R can be used to archive data or for storing and distributing video material.

BD-RE

A BD-RE(Blu-ray Disc Rewritable) is a recordable and rewritable Blu-ray Disc.

BD-ROM

BD-ROMs(Blu-ray Disc Read-Only Memory) are commercially produced discs. Other than conventional movie and video contents, these discs have enhanced features such as interactive content, menu operations using pop-up menus, selection of subtitle display, and slide shows. Although a BD-ROM may contain any form of data, most BD-ROM discs will contain movies in High Definition format for playback on Blu-ray Disc players.

Blu-ray Disc(BD)

A disc format developed for recording/playing high-definition (HD) video (for HDTV, etc.), and for storing large amounts of data. A single layer Blu-ray Disc holds up to 25 GB, and a dual-layer Blu-ray Disc holds up to 50 GB of data.

- “Blu-ray Disc”, “Blu-ray” and “Blu-ray Disc” logo are trademarks of Blu-ray Disc Association.

BonusView

Some BD-ROMs have bonus contents and other data that can be downloaded to the external memory(local storage) for enjoyment.

- “BONUSVIEW” is trademark of Blu-ray Disc Association.

Dolby Digital

A sound system developed by Dolby Laboratories Inc. that gives movie theater ambience to audio output when the product is connected to a Dolby Digital processor or amplifier.

Dolby Digital Plus

A sound system developed as an extension to Dolby Digital. This audio coding technology supports 7.1 multi-channel surround sound.

Dolby TrueHD

Dolby TrueHD is a lossless coding technology that supports up to 8 channels of multi-channel surround sound for the next generation optical discs. The reproduced sound is true to the original source bit-for-bit.

- Manufactured under license from Dolby Laboratories. Dolby and the double-D symbol are trademarks of Dolby Laboratories.

DTS

This is a digital sound system developed by DTS, Inc. for use in cinemas.

DTS-HD High Resolution Audio

DTS-HD High Resolution Audio is a new technology developed for the next generation high definition optical disc format.

DTS-HD Master Audio

DTS-HD Master Audio is a lossless audio compression technology developed for the next generation high definition optical disc format.

- Manufactured under license under U.S. Patent #'s: 5,451,942; 5,956,674; 5,974,380; 5,978,762; 6,226,616; 6,487,535; 7,212,872; 7,333,929; 7,392,195; 7,272,567 & other U.S. and worldwide patents issued & pending. DTS and the Symbol are registered trademarks, & DTS-HD, DTS-HD Master Audio, and the DTS logos are trademarks of DTS, Inc. Product includes software.© DTS, Inc. All Rights Reserved.

DVD Video

A disc format for storing MPEG-2 video on DVD, with interactive menus, multiple soundtracks, subtitles, camera angles, and so on.

-  is a trademark of DVD format/Logo licensing Corporation.

DVD-R

A DVD-R is a recordable, write-once DVD.

DVD-RW

A DVD-RW is a recordable and rewritable DVD. The DVD-R/-RW has two different formats: VR format and Video format. DVDs created in Video format have the same format as a DVD video, while discs created in VR (Video Recording) format allow the contents to be programed or edited.

HDMI

HDMI(High Definition Multimedia Interface) is a new connection format that supports both video and audio on a single digital connection.

The HDMI connection carries uncompressed, standard or high definition digital video signals and multi-channel audio signals to AV components such as HDMI equipped TVs, in digital form without degradation.

- HDMI, the HDMI logo and High-Definition Multimedia Interface are trademarks or registered trademarks of HDMI Licensing LLC.

Interlace format

Interlace format shows every other line of an image as a single "field" and is the standard method for displaying images on television. The even numbered field shows the even numbered lines of an image, and the odd numbered field shows the odd numbered lines of an image.

JPEG(Joint Photographic Experts Group)

JPEG is a popular file format for still image compression and storage.

Linear PCM

Linear PCM is a signal recording format used for Audio CDs and on some DVD and Blu-ray discs. The sound on Audio CDs is recorded at 44.1 kHz with 16 bits. (Sound is recorded between 48 kHz with 16 bits and 96 kHz with 24 bits on DVD video discs and between 49 kHz with 16 bits and 192 kHz with 24 bits on BD video discs.)

MPEG-2

MPEG-2 (Moving Picture Experts Group phase 2) is one of the video data compression schemes, which is adopted for DVD videos and digital broadcasts worldwide. Some Blu-ray Discs also use high bitrate MPEG-2.

MP3

MP3 is an audio data compression format, which stands for MPEG-1 Audio Layer 3. Using MP3, you can achieve a data reduction of about 1:10.

- MPEG Layer-3 audio coding technology licensed from Fraunhofer IIS and Thomson.

Multi Angle

This is a feature of DVD and BD video discs. In some discs, the same scene is shot from different angles, and these are stored in a single disc so you can enjoy playback from each angle.

Multi Audio

This is a feature of DVD and BD video discs. This function makes it possible to record different audio tracks for the same video, so you can enhance your enjoyment by switching the audio.

Pop-up menu

An enhanced menu operation available on BD video discs. The pop-up menu appears when **POPUP MENU** is pressed during playback, and can be operated while playback is in progress.

Progressive format

Compared to the Interlace format that alternately shows every other line of an image (field) to create one frame, the Progressive format shows the entire image at once as a single frame. This means that while the Interlace format can show 30 frames/60 fields in one second, the Progressive format can show 60 frames in one second. The overall picture quality increases and still images, text, and horizontal lines appear sharper.

Subtitle

These are the lines of text appearing at the bottom of the screen which translate or transcribe the dialog. They are recorded on many DVD and BD video discs.

WMA(Windows Media™ Audio)

WMA is an audio data compression format developed by Microsoft Corporation. WMA file size is smaller than that of MP3.

WMV(Windows Media™ Video)

WMV is a video data compression format by Microsoft Corporation.

- Windows Media and the Windows logo are trademarks or registered trademarks of Microsoft Corporation in the United States and/or other countries.

BD/DVD Video structure

BD/DVD Video discs typically one or more titles, which may be subdivided into chapters.

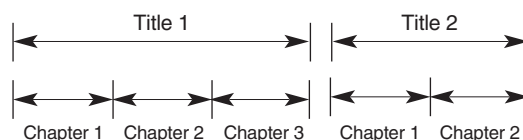

Audio CD

Audio CDs contain tracks.

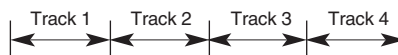

MP3/WMA/JPEG/AVI/WMV structure

On an MP3/WMA/JPEG/AVI/WMV disc, a folder can be a member of another folder, creating hierarchical folder layers. If you are familiar with a personal computer, you may easily understand the hierarchical file/folder construction.

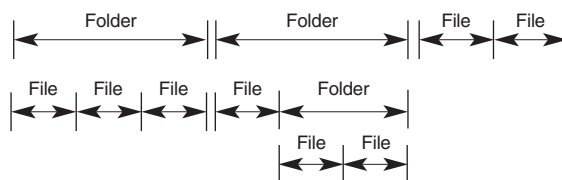

Troubleshooting Guide

If a fault occurs, run through the table below before taking your unit for repair.

If the fault persists, attempt to solve it by switching the unit off and on again. If this fails to resolve the situation, consult your dealer. Under no circumstances should you repair the unit yourself as this will invalidate the guarantee!

PROBLEM	POSSIBLE CAUSE	REMEDY
No power	<ul style="list-style-type: none"> The AC input cord is disconnected. Poor connection at AC wall outlet or the outlet is inactive. 	<ul style="list-style-type: none"> Connect cord securely. Check the outlet using a lamp or another appliance.
No playback	<ul style="list-style-type: none"> The disc is loaded upside down. The disc is not playable. The disc is dirty. The recorded disc is not correctly finalized. The parental level is not set correctly. <p>The symbol about invalid operation is displayed.</p>	<ul style="list-style-type: none"> Reload the disc with the printed side up. Use a playable disc. Clean the disc. Load a disc that is correctly finalized. Set the parental level setting correctly. (Refer to "SETTING THE PARENTAL CONTROL" on page 34.) Adjust the setting correctly. (Refer to "SYMBOL ABOUT INVALID OPERATION" on page 16.)
Malfunction	<ul style="list-style-type: none"> The disc is scratched, dirty badly or unplayable. 	<ul style="list-style-type: none"> Press the POWER ON/STANDBY button to turn the power off, press the POWER ON/STANDBY button again and then unload the disc.
No picture	<ul style="list-style-type: none"> The video cords are disconnected. The incorrect selection of input source on the TV. The disc is not playable. 	<ul style="list-style-type: none"> Connect the cords correctly. Select the input source correctly. Use a playable disc.
Noisy or distorted picture	<ul style="list-style-type: none"> The unit is connected to a VCR directly and the copyguard function is activated. The disc is dirty. It is in rapid advance or reverse playback, or in frame advance playback. 	<ul style="list-style-type: none"> Connect the unit so that the picture signal is transferred directly to the TV. Clean the disc. Sometimes small amount of picture distortion may appear. This is not malfunction.
Abnormal picture or no picture	<ul style="list-style-type: none"> The resolution is not set correctly for video signals to be output from the COMPONENT and the HDMI OUTs. The TV does not support HDCP. <p>The TV type of this unit is different from that of your TV or the disc.</p>	<ul style="list-style-type: none"> Set the resolution correctly. (Refer to "SETTING THE DISPLAY" on page 31.) This unit will not transfer the video signals via HDMI connector to TV that does not support HDCP. This is not malfunction. Set the TV type correctly. (Refer to "SETTING THE DISPLAY" on page 31.)
Slight pause of picture	<ul style="list-style-type: none"> The layer transition occurs during playback of DVD Videos recorded in dual-layer format. 	<ul style="list-style-type: none"> Sometimes slight pause may occur. This is not malfunction.
No sound	<ul style="list-style-type: none"> The audio cords are disconnected. The speakers are disconnected to the amplifier. The incorrect selection of input source on the amplifier. 	<ul style="list-style-type: none"> Connect the cords correctly. Connect the speakers correctly. Select the input source correctly.
Noisy or distorted sound	<ul style="list-style-type: none"> The disc is dirty. Poor connections. 	<ul style="list-style-type: none"> Clean the disc. Check the connections and connect all cords securely.
BD-LIVE contents cannot be loaded	<ul style="list-style-type: none"> Poor connections between this unit and broadband router and/or modem. The USB memory device is disconnected. The BD-Live Internet Access is set to "Prohibit Access". The BD Video disc does not support BD-LIVE. The network settings are not set correctly. 	<ul style="list-style-type: none"> Check the connections and connect all cords securely. Connect the USB memory device to this unit. Set it to "Always Allow Access" (Refer to "SETTING THE SYSTEM" on page 30.) Load a disc that supports BD-LIVE. Set the network settings correctly. (Refer to "SETTING THE NETWORK" on page 35.)
Remote control unit does not operate.	<ul style="list-style-type: none"> Batteries are not loaded or exhausted. The remote sensor is obstructed. 	<ul style="list-style-type: none"> Replace the batteries. Remove the obstacle.

Specifications

SYSTEM

- Type | **Blu-ray Disc Player**
- Laser | **Semiconductor laser**
- Video Signal System
 - U.S.A. and Canada | **NTSC**
 - Europe | **PAL**

AUDIO SECTION

- Frequency response
 - BD (Linear PCM), Sampling frequency : 48 kHz | **20 Hz~22 kHz**
 - Sampling frequency : 96 kHz | **20 Hz~44 kHz**
 - Sampling frequency : 192 kHz | **20 Hz~88 kHz**
 - DVD (Linear PCM), Sampling frequency : 48 kHz | **20 Hz~22 kHz**
 - Sampling frequency : 96 kHz | **20 Hz~44 kHz**
 - CD, Sampling frequency : 44.1 kHz | **20 Hz~20 kHz**
- Signal to noise ratio, IHF "A" weighted | **100 dB**
- Dynamic range
 - BD / DVD / CD | **100 dB / 100 dB / 98 dB**
- Total harmonic distortion, 1 kHz | **0.003 %**
- Wow and flutter | **Unmeasurable(less than ± 0.002 %)**
- Analog output level, 10 k Ω | **2.0 V**
- Digital output level
 - Coaxial, 75 Ω | **0.5 Vp-p**
 - Optical, 660 nm | **-21 ~ 15 dBm**

VIDEO SECTION

- Output level, 75 Ω
 - Video (regular, COMPOSITE) | **1.0 Vp-p**
 - COMPONENT : Y / Pb / Pr | **1.0 / 0.7 / 0.7 Vp-p**
 - HDMI output | **19 pin**

GENERAL

- BD Storage / Service | **USB 2.0 High Speed (480 Mbit/s)**
- LAN | **10 BASE-T / 100 BASE-TX**
- Power supply
 - U.S.A. and Canada | **120 V ~ 60 Hz**
 - Europe | **230 V ~ 50 Hz**
- Power consumption | **25 W**
- Operating temperature | **+41°F ~ +95°F (+5°C ~ +35°C)**
- Dimensions(W x H x D, including protruding parts) | **435 x 102.5 x 280 mm(17-1/8 x 4 x 11 inches)**
- Weight(Net) | **4.55 kg(10 lbs)**

Note: Design and specifications are subject to change without notice for improvements.

License

- This product uses some software programs which are distributed under the GPL license. Accordingly, the following GPL software source codes that have been used in this product can be provided after asking at <http://www.anthemav.com>.

GNU GENERAL PUBLIC LICENSE

Version 2, June 1991

Copyright (C) 1989, 1991 Free Software Foundation, Inc.
51 Franklin Street, Fifth Floor, Boston, MA 02110-1301, USA

Everyone is permitted to copy and distribute verbatim copies of this license document, but changing it is not allowed.

Preamble

The licenses for most software are designed to take away your freedom to share and change it. By contrast, the GNU General Public License is intended to guarantee your freedom to share and change free software--to make sure the software is free for all its users. This General Public License applies to most of the Free Software Foundation's software and to any other program whose authors commit to using it. (Some other Free Software Foundation software is covered by the GNU Lesser General Public License instead.) You can apply it to your programs, too.

When we speak of free software, we are referring to freedom, not price. Our General Public Licenses are designed to make sure that you have the freedom to distribute copies of free software (and charge for this service if you wish), that you receive source code or can get it if you want it, that you can change the software or use pieces of it in new free programs; and that you know you can do these things.

To protect your rights, we need to make restrictions that forbid anyone to deny you these rights or to ask you to surrender the rights. These restrictions translate to certain responsibilities for you if you distribute copies of the software, or if you modify it.

For example, if you distribute copies of such a program, whether gratis or for a fee, you must give the recipients all the rights that you have. You must make sure that they, too, receive or can get the source code. And you must show them these terms so they know their rights.

We protect your rights with two steps: (1) copyright the software, and (2) offer you this license which gives you legal permission to copy, distribute and/or modify the software.

Also, for each author's protection and ours, we want to make certain that everyone understands that there is no warranty for this free software. If the software is modified by someone else and passed on, we want its recipients to know that what they have is not the original, so that any problems introduced by others will not reflect on the original authors' reputations.

Finally, any free program is threatened constantly by software patents. We wish to avoid the danger that redistributors of a free program will individually obtain patent licenses, in effect making the program proprietary. To prevent this, we have made it clear that any patent must be licensed for everyone's free use or not licensed at all.

The precise terms and conditions for copying, distribution and modification follow.

TERMS AND CONDITIONS FOR COPYING, DISTRIBUTION AND MODIFICATION

0. This License applies to any program or other work which contains a notice placed by the copyright holder saying it may be distributed under the terms of this General Public License. The "Program", below, refers to any such program or work, and a "work based on the Program" means either the Program or any derivative work under copyright law: that is to say, a work containing the Program or a portion of it, either verbatim or with modifications and/or translated into another language. (Hereinafter, translation is included without limitation in the term "modification".) Each licensee is addressed as "you".

Activities other than copying, distribution and modification are not covered by this License; they are outside its scope. The act of running the Program is not restricted, and the output from the Program is covered only if its contents constitute a work based on the Program (independent of having been made by running the Program). Whether that is true depends on what the Program does.

1. You may copy and distribute verbatim copies of the Program's source code as you receive it, in any medium, provided that you conspicuously and appropriately publish on each copy an appropriate copyright notice and disclaimer of warranty; keep intact all the notices that refer to this License and to the absence of any warranty; and give any other recipients of the Program a copy of this License along with the Program.

You may charge a fee for the physical act of transferring a copy, and you may at your option offer warranty protection in exchange for a fee.

2. You may modify your copy or copies of the Program or any portion of it, thus forming a work based on the Program, and copy and distribute such modifications or work under the terms of Section 1 above, provided that you also meet all of these conditions:

- a) You must cause the modified files to carry prominent notices stating that you changed the files and the date of any change.
- b) You must cause any work that you distribute or publish, that in whole or in part contains or is derived from the Program or any part thereof, to be licensed as a whole at no charge to all third parties under the terms of this License.
- c) If the modified program normally reads commands interactively when run, you must cause it, when started running for such interactive use in the most ordinary way, to print or display an announcement including an appropriate copyright notice and a notice that there is no warranty (or else, saying that you provide a warranty) and that users may redistribute the program under these conditions, and telling the user how to view a copy of this License. (Exception: if the Program itself is interactive but does not normally print such an announcement, your work based on the Program is not required to print an announcement.)

These requirements apply to the modified work as a whole. If identifiable sections of that work are not derived from the Program, and can be reasonably considered independent and separate works in themselves, then this License, and its terms, do not apply to those sections when you distribute them as separate works. But when you distribute the same sections as part of a whole which is a work based on the Program, the distribution of the whole must be on the terms of this License, whose permissions for other licensees extend to the entire whole, and thus to each and every part regardless of who wrote it.

Thus, it is not the intent of this section to claim rights or contest your rights to work written entirely by you; rather, the intent is to exercise the right to control the distribution of derivative or collective works based on the Program.

In addition, mere aggregation of another work not based on the Program with the Program (or with a work based on the Program) on a volume of a storage or distribution medium does not bring the other work under the scope of this License.

3. You may copy and distribute the Program (or a work based on it, under Section 2) in object code or executable form under the terms of Sections 1 and 2 above provided that you also do one of the following:

- a) Accompany it with the complete corresponding machine-readable source code, which must be distributed under the terms of Sections 1 and 2 above on a medium customarily used for software interchange; or,
- b) Accompany it with a written offer, valid for at least three years, to give any third party, for a charge no more than your cost of physically performing source distribution, a complete machine-readable copy of the corresponding source code, to be distributed under the terms of Sections 1 and 2 above on a medium customarily used for software interchange; or,
- c) Accompany it with the information you received as to the offer to distribute corresponding source code. (This alternative is allowed only for noncommercial distribution and only if you received the program in object code or executable form with such an offer, in accord with Subsection b above.)

The source code for a work means the preferred form of the work for making modifications to it. For an executable work, complete source code means all the source code for all modules it contains, plus any associated interface definition files, plus the scripts used to control compilation and installation of the executable. However, as a special exception, the source code distributed need not include anything that is normally distributed (in either source or binary form) with the major components (compiler, kernel, and so on) of the operating system on which the executable runs, unless that component itself accompanies the executable.

If distribution of executable or object code is made by offering access to copy from a designated place, then offering equivalent access to copy the source code from the same place counts as distribution of the source code, even though third parties are not compelled to copy the source along with the object code.

4. You may not copy, modify, sublicense, or distribute the Program except as expressly provided under this License. Any attempt otherwise to copy, modify, sublicense or distribute the Program is void, and will automatically terminate your rights under this License. However, parties who have received copies, or rights, from you under this License will not have their licenses terminated so long as such parties remain in full compliance.

5. You are not required to accept this License, since you have not signed it. However, nothing else grants you permission to modify or distribute the Program or its derivative works. These actions are prohibited by law if you do not accept this License. Therefore, by modifying or distributing the Program (or any work based on the Program), you indicate your acceptance of this License to do so, and all its terms and conditions for copying, distributing or modifying the Program or works based on it.
6. Each time you redistribute the Program (or any work based on the Program), the recipient automatically receives a license from the original licensor to copy, distribute or modify the Program subject to these terms and conditions. You may not impose any further restrictions on the recipients' exercise of the rights granted herein. You are not responsible for enforcing compliance by third parties to this License.
7. If, as a consequence of a court judgment or allegation of patent infringement or for any other reason (not limited to patent issues), conditions are imposed on you (whether by court order, agreement or otherwise) that contradict the conditions of this License, they do not excuse you from the conditions of this License. If you cannot distribute so as to satisfy simultaneously your obligations under this License and any other pertinent obligations, then as a consequence you may not distribute the Program at all. For example, if a patent license would not permit royalty-free redistribution of the Program by all those who receive copies directly or indirectly through you, then the only way you could satisfy both it and this License would be to refrain entirely from distribution of the Program.

If any portion of this section is held invalid or unenforceable under any particular circumstance, the balance of the section is intended to apply and the section as a whole is intended to apply in other circumstances.

It is not the purpose of this section to induce you to infringe any patents or other property right claims or to contest validity of any such claims; this section has the sole purpose of protecting the integrity of the free software distribution system, which is implemented by public license practices. Many people have made generous contributions to the wide range of software distributed through that system in reliance on consistent application of that system; it is up to the author/donor to decide if he or she is willing to distribute software through any other system and a licensee cannot impose that choice.

This section is intended to make thoroughly clear what is believed to be a consequence of the rest of this License.

8. If the distribution and/or use of the Program is restricted in certain countries either by patents or by copyrighted interfaces, the original copyright holder who places the Program under this License may add an explicit geographical distribution limitation excluding those countries, so that distribution is permitted only in or among countries not thus excluded. In such case, this License incorporates the limitation as if written in the body of this License.
9. The Free Software Foundation may publish revised and/or new versions of the General Public License from time to time. Such new versions will be similar in spirit to the present version, but may differ in detail to address new problems or concerns.

Each version is given a distinguishing version number. If the Program specifies a version number of this License which applies to it and "any later version", you have the option of following the terms and conditions either of that version or of any later version published by the Free Software Foundation. If the Program does not specify a version number of this License, you may choose any version ever published by the Free Software Foundation.

10. If you wish to incorporate parts of the Program into other free programs whose distribution conditions are different, write to the author to ask for permission. For software which is copyrighted by the Free Software Foundation, write to the Free Software Foundation; we sometimes make exceptions for this. Our decision will be guided by the two goals of preserving the free status of all derivatives of our free software and of promoting the sharing and reuse of software generally.

NO WARRANTY

11. BECAUSE THE PROGRAM IS LICENSED FREE OF CHARGE, THERE IS NO WARRANTY FOR THE PROGRAM, TO THE EXTENT PERMITTED BY APPLICABLE LAW. EXCEPT WHEN OTHERWISE STATED IN WRITING THE COPYRIGHT HOLDERS AND/OR OTHER PARTIES PROVIDE THE PROGRAM "AS IS" WITHOUT WARRANTY OF ANY KIND, EITHER EXPRESSED OR IMPLIED, INCLUDING, BUT NOT LIMITED TO, THE IMPLIED WARRANTIES OF MERCHANTABILITY AND FITNESS FOR A PARTICULAR PURPOSE. THE ENTIRE RISK AS TO THE QUALITY AND PERFORMANCE OF THE PROGRAM IS WITH YOU. SHOULD THE PROGRAM PROVE DEFECTIVE, YOU ASSUME THE COST OF ALL NECESSARY SERVICING, REPAIR OR CORRECTION.
12. IN NO EVENT UNLESS REQUIRED BY APPLICABLE LAW OR AGREED TO IN WRITING WILL ANY COPYRIGHT HOLDER, OR ANY OTHER PARTY WHO MAY MODIFY AND/OR REDISTRIBUTE THE PROGRAM AS PERMITTED ABOVE, BE LIABLE TO YOU FOR DAMAGES, INCLUDING ANY GENERAL, SPECIAL, INCIDENTAL OR CONSEQUENTIAL DAMAGES ARISING OUT OF THE USE OR INABILITY TO USE THE PROGRAM (INCLUDING BUT

NOT LIMITED TO LOSS OF DATA OR DATA BEING RENDERED INACCURATE OR LOSSES SUSTAINED BY YOU OR THIRD PARTIES OR A FAILURE OF THE PROGRAM TO OPERATE WITH ANY OTHER PROGRAMS), EVEN IF SUCH HOLDER OR OTHER PARTY HAS BEEN ADVISED OF THE POSSIBILITY OF SUCH DAMAGES.

END OF TERMS AND CONDITIONS

How to Apply These Terms to Your New Programs

If you develop a new program, and you want it to be of the greatest possible use to the public, the best way to achieve this is to make it free software which everyone can redistribute and change under these terms.

To do so, attach the following notices to the program. It is safest to attach them to the start of each source file to most effectively convey the exclusion of warranty; and each file should have at least the “copyright” line and a pointer to where the full notice is found.

One line to give the program’s name and a brief idea of what it does.

Copyright (C) <year><name of author>

This program is free software; you can redistribute it and/or modify it under the terms of the GNU General Public License as published by the Free Software Foundation; either version 2 of the License, or (at your option) any later version.

This program is distributed in the hope that it will be useful, but WITHOUT ANY WARRANTY; without even the implied warranty of MERCHANTABILITY or FITNESS FOR A PARTICULAR PURPOSE. See the GNU General Public License for more details.

You should have received a copy of the GNU General Public License along with this program; if not, write to the Free Software Foundation, Inc., 59 Temple Place, Suite 330, Boston, MA 02111-1307 USA

Also add information on how to contact you by electronic and paper mail.

If the program is interactive, make it output a short notice like this when it starts in an interactive mode:

Gnomovision version 69, Copyright (C) year name of author Gnomovision comes with ABSOLUTELY NO WARRANTY; for details type ‘show w’. This is free software, and you are welcome to redistribute it under certain conditions; type ‘show c’ for details.

The hypothetical commands ‘show w’ and ‘show c’ should show the appropriate parts of the General Public License. Of course, the commands you use may be called something other than ‘show w’ and ‘show c’; they could even be mouse-clicks or menu items--whatever suits your program.

You should also get your employer (if you work as a programmer) or your school, if any, to sign a “copyright disclaimer” for the program, if necessary. Here is a sample; alter the names:

Yoyodyne, Inc., hereby disclaims all copyright interest in the program ‘Gnomovision’ (which makes passes at compilers) written by James Hacker.
signature of Ty Coon, 1 April 1989
Ty Coon, President of Vice

This General Public License does not permit incorporating your program into proprietary programs. If your program is subroutine library, you may consider it more useful to permit linking proprietary applications with the library. If this is what you want to do, use the GNU Library General Public License instead of this License.

Limited Warranty

CANADA & USA

The warranty period on Anthem products is five (5) years for power amplifiers and integrated amplifiers, three (3) years for audio preamplifiers and audio processing, two (2) years for video equipment and video processing, one (1) year for remote controls, and six (6) months for projector lamps from date of purchase from Anthem or an Authorized Anthem Dealer. If Anthem determines that the product has a defect in materials or manufacturing during the period Anthem will at its option repair, replace or provide the necessary replacement parts without charging for parts or labor. Repaired or replaced equipment or parts supplied under this warranty are covered by the unexpired portion of the warranty.

This warranty is transferable only if the re-sold product is purchased from an Authorized Anthem Dealer. Display products sold by an Authorized Anthem Dealer are covered by the same warranty except that the period commences on the date of the dealer invoice, not the purchaser's invoice, and cosmetic flaws are excluded.

Warranty is void if the serial number has been removed, altered or defaced, if the product has been operated, installed or handled other than in accordance with the intended application, tampered with, modified, or damaged by accident, while in transport or by failure of electric power, or has been repaired by a non-authorized party. Anthem shall have no obligation to correct any defect that is not reproducible by Anthem. If inspection by Anthem discloses that the repair required is not covered by this warranty, regular repair charges shall apply.

If a problem is discovered in your Anthem product, please contact the Authorized Anthem Dealer from whom you purchased the product. Your dealer will help to determine the cause of the problem and arrange for the appropriate action. Alternatively, follow the procedure below for factory service.

A Return Authorization (RA) number must be obtained from Anthem Technical Support before a product can be shipped to Anthem for any reason. Product shipped to Anthem without its RA Number clearly visible on the outside of the shipping carton will be refused and returned to the sender, freight collect. Product shipped to Anthem must have shipping and insurance prepaid by the sender, be packaged in the original carton and packing material and accompanied by a written description of the defect. Service will not be given under warranty without an accompanying copy of the sales invoice. Product repaired under warranty will be returned with shipping and insurance prepaid by Anthem (within Canada and continental USA only).

Disclaimer of Liability

Under no circumstances shall Anthem, its agents, representatives or employees assume liability or responsibility for injury or damages sustained in the use or operation of Anthem products or for damages to connected products. Some jurisdictions do not allow limitations of incidental or consequential damages so this exclusion may not apply to you.

Anthem reserves the right to make design changes without obligation to revise prior versions. All specifications are subject to change without notice.

This warranty shall be the sole and exclusive remedy to you. No other warranty or condition, statutory or otherwise, expressed or implied, shall be imposed upon Anthem nor shall any representation made by any person, including a representative or agent of Anthem, be effective to extend the warranty coverage provided herein.

On the expiration of the warranty all liability of Anthem in connection with the product shall terminate.

INTERNATIONAL

Terms and conditions are set and maintained by the Authorized Anthem Distributor, not Anthem.

BLX 200

BLU-RAY DISC PLAYER

A N T H E M

tel. (+1) 905-362-0958 M-F 9:00 am - 5:30 pm (ET)

www.anthemAV.com

OM-1006

5707-00000-294-0S
101409